

# **RADIO** *1980s and Television* **TODAY**



**EARN EXTRA DOLLARS AS BUTTONS ARE RE-SET FOR MAR. 29 SHIFT**

**FEBRUARY**



**PROVEN FOR PERFORMANCE**  
*in millions of Auto Radios*

**PROVEN FOR PROFITS**  
*by thousands of Service Men*



In the great majority of all auto radios and battery operated home receivers, Mallory-made Vibrators are standard original equipment. They have won this leadership through performance alone. In every case, they have been adopted by the set manufacturer, only after exhaustive efficiency and life tests.

Mallory Vibrators for replacement are identical in construction, quality and performance to those supplied for original equipment. Thousands of radio service engineers have found Mallory Vibrators the most profitable line they could handle because they insure customer satisfaction and eliminate troublesome comebacks.

Safeguard your reputation for superior service by insisting on the best. Remember, Mallory Vibrators cost no more!

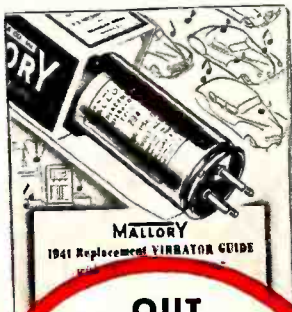

**OUT**  
**MARCH 1st,**  
**Vibrator Replacement**  
**Guide**  
*Order from*  
*your distributor*  
**NOW!**  
*—It's Free*

**P. R. MALLORY & CO., Inc.**  
**MALLORY**  
**VIBRATORS**



P. R. MALLORY & CO., Inc., INDIANAPOLIS, INDIANA

Cable Address  
 PELMALLO

*More*  
*than ever*  
**—INSIST ON**

**P. R. MALLORY & CO., Inc.**  
**MALLORY**  
 APPROVED  
 PRECISION PRODUCTS

VIBRATORS • VIBRAPACKS • CONDENSERS •  
 VOLUME CONTROLS • ROTARY SWITCHES •  
 SINGLE AND MULTIPLE PUSH BUTTON SWITCHES  
 • RESISTORS • RADIO HARDWARE

# ARVIN *Car Radio*

## "FOUR-ACES" DEAL

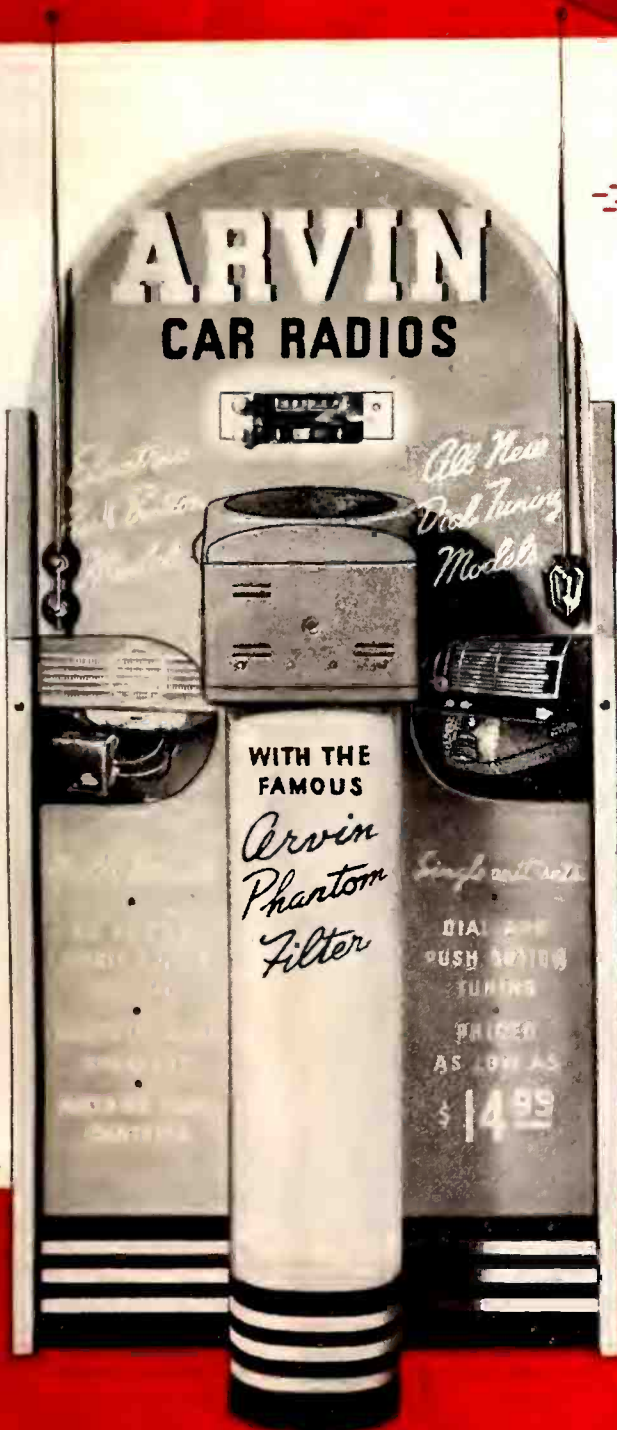

Here's how you deal yourself 4 Aces in the car radio profit game

- 1** Order four or more of the new 1941 Arvin Car Radios, during January, February or March, including at least one electric tuning model.
- 2** You receive a late Spring dating on this initial order.
- 3** You receive *FREE Sales Tools*—an attractive floor display demonstrator, wall poster, consumer folders and other selling helps.
- 4** You receive a *FREE CHAIR* for your service station or home—one of the famous Arvin All-Metal Outdoor Chairs with initial order for 4 radios—2 chairs with eight radios. But this special offer expires March 31, 1941.



Free Sales Material and Free Chair are shipped direct from factory, freight paid. Radios come from your jabber. You just can't "pass" on a deal like this!

NOBLITT-SPARKS INDUSTRIES, INC., COLUMBUS, INDIANA

Prices Slightly Higher West and South



**FREE** with the Arvin "Four Aces" Deal. This floor display demonstrator is a sales material provided for display and actual demonstration of any Arvin model. Beautifully decorated with striking red, yellow and black color combination. Stands nearly five feet high.

**GIANT WALL POSTER** five feet wide by three feet high. Smaller than other message signs and hold attention. Features Electric Push Button Tuning and other Arvin models. **FREE** with Arvin "Four Aces" Deal.

# Slide-A-Way

## PHONOGRAPH WITH AUTOMATIC RECORD CHANGER

WITH NEW



EXCLUSIVELY IN THIS  
1941

# Admiral

## 6 TUBE AC RADIO WITH BAND SPREAD SHORT WAVE

*Model 71-M6.* Open the doors . . . and slides Admiral's new and exclusive "Slide-A-Way" phonograph with its automatic record changer and Pfanstiehl Lifetime Needle. The last word in convenience! No stooping to peer into a cubby hole; no ornaments to remove from the top. Handsomely styled cabinet of beautiful matched walnut measures 30 $\frac{3}{4}$ " x 39" x 16 $\frac{1}{2}$ ".

**CHASSIS:** 6 tubes; AC superhet.; super Aeroscope; 10" P.M. dynamic speaker; bass compensation; variable tone control; automatic volume control; large, colorful "Sofglo" airplane dial and beautiful soft gold escutcheon; two wave bands—standard (540 to 1630 K.C.) and Magna-Band tuning on European 31 meter band. "Slide-A-Way" automatic record changer unit (roller bearings) plays ten 12" or twelve 10" records.

Model 71-M6

**\$69.95**



Prices slightly higher in Far West and South and subject to change without notice. Admiral Radios are equipped with RCA preferred type tubes.

# PfANSTIEHL LIFETIME NEEDLE

will last a lifetime in ordinary home use. No more needles to change.

# PHONO RADIO TABLE MODELS with AUTOMATIC RECORD CHANGER



Model 69-M5. Another amazing value in Admiral's line of low-priced radio-phonographs with automatic record changer on the market. Equipped with Pfanstiehl Lifetime Needle. Performance that compares with the best. New radio circuit developed by Admiral produces remarkable power output. Attractive walnut cabinet measures 17 1/4" x 12 1/2" x 16 1/2"

Model 69-M5

**\$39.95**

CHASSIS: 5 multi-purpose tubes; full AC-DC superhet. circuit; super Aeroscope; beam power output; full-size heavy duty P.M. dynamic speaker; automatic volume control; large colorful "Softglo" airplane dial; covers standard broadcast band (540 to 1630 K.C.); Admiral automatic record changer plays twelve 10" or ten 12" records.

Model 70-N6. Compare it with any for appearance! Compare it with the most expensive for performance! Here's a value that tops them all! 6 multi purpose tubes; AC superhet. covers standard broadcast band (545 to 1630 K.C.). Has variable volume control; bass compensation; 6" P.M. dynamic speaker; automatic volume control; super Aeroscope; high power output; smartly styled walnut cabinet. Admiral automatic record changer plays twelve 10" or ten 12" records. Equipped with Pfanstiehl Lifetime Needle.

## ADMIRAL RECORD CABINETS

Here are two smartly styled record cabinets with compartments for eight record albums. Each is designed to harmonize perfectly with either of the two models illustrated above. Complete with one 12" and four 10" albums. Sold at a sensational price when purchased with an Admiral table model radio-phonograph



Model 101



Model 102 Deluxe



Model 70-N6

**\$49.95**

## CONTINENTAL RADIO & TELEVISION CORP.

3800 W. CORTLAND ST., CHICAGO, ILL.

Export Office: 116 Broad St., New York

Originators of Tilt-Tuning . . . Touch-O-Matic . . . Aeroscope . . . Slide-A-Way

# Slide-A-Way

PHONOGRAPH WITH  
AUTOMATIC RECORD CHANGER

EXCLUSIVELY IN THE U.S.A.

# Admiral

## 6 TUBE AC RADIO WITH BAND SPREAD SHORT WAVE

Model 71-M6. Open the doors . . . out slides Admiral's new and exclusive "Slide-A-Way" phonograph with its automatic record changer and Pfanstiehl Lifetime Needle. The last word in convenience! No stooping to peer into a cubby hole; no ornaments to remove from the top. Handsomely styled cabinet of beautiful matched walnut measures 30 3/4" x 39" x 16 1/2".

CHASSIS: 6 tubes; AC superhet; super Aerescope; 10" P.M. dynamic speaker; bass compensation; variable tone control; automatic volume control; large, colorful "Softglo" airplane dial and beautiful soft gold escutcheon; two wave bands—standard (540 to 1630 K.C.) and Magna-Band tuning on European 31 meter band; "Slide-A-Way" automatic record changer unit (roller bearings) plays ten 12" or twelve 10" records.

Model 71-M6

**\$69.95**



Prices slightly higher in Far West and South and subject to change without notice. Admiral Radios are equipped with RCA preferred type tubes.

WITH NEW



**PFANSTIEHL  
LIFETIME  
NEEDLE**  
Will last a lifetime in ordinary home use. No more needles to change.

## PHONO RADIO TABLE MODELS with **AUTOMATIC RECORD CHANGER**



Model 70-N6

**\$39.95**

Model 70-N6. Compare it with any for appearance! Compare it with the most expensive for performance! Here's a value that tops them all! 6 multi purpose tubes; AC superhet. covers standard broadcast band (545 to 1630 K.C.). Has variable tone control; bass compensation; 6" P.M. dynamic speaker; automatic volume control; super Aerescope; high power output; smartly styled walnut cabinet. Admiral automatic record changer plays twelve 10" or ten 12" records. Equipped with Pfanstiehl Lifetime Needle.

### ADMIRAL RECORD CABINETS

Here are two smartly styled record cabinets with compartments for eight record albums. Each is designed to harmonize perfectly with either of the two models illustrated above. Complete with one 12" and four 10" albums. Sold at a sensational price when purchased with an Admiral table model radio-phonograph.



Model 101



Model 102 Deluxe



Model 102

**\$49.95**

CHASSIS: 5 multi-purpose tubes; full AC-DC superhet circuit; super Aerescope; beam power output; full-size heavy duty P.M. dynamic speaker; automatic volume control; large colorful "Softglo" airplane dial; covers standard broadcast band (540 to 1630 K.C.); Admiral automatic record changer plays twelve 10" or ten 12" records.

### CONTINENTAL RADIO & TELEVISION CORP.

3800 W. CORTLAND ST., CHICAGO, ILL.  
Export Office: 116 Broad St., New York  
Originators of Tilt-Tuning . . . Touch-O-Matic . . . Aerescope . . . Slide-A-Way



\$  
19.95\*

## 3-WAY CIRCUIT

in the new Camera-type Portable CT-59. Operates on AC, DC or batteries. Customers plug in—save batteries. On-off switch on side of case serves as both safety-slide switch and door catch, preventing accidental battery drainage.

5 tubes. Extreme sensitivity and selectivity. Amazingly good tone. The case is made of non-breakable beige plastic. Leatherette trim in lighter beige. It's a beauty! All your customers will want this new kind of radio.

# THEY'RE HERE!

## The first of the great new FARNSWORTH LINE

### ● Two Sensational New Value-Leaders

Farnsworth has set the pace with merchandise the public sees, wants, *buys!* Just look at these pictures of the brand-new Farnsworth Camera-type Portable and Farnsworth Luggage-type Portable. Note their smart, advanced design . . . with "sellability" in every line. Check the amazing list of features that gives them a brilliance in performance and appearance you *never dreamed possible in a portable.*

### ● Forerunners of Big Things Yet to Come

You know radios. That's your *business!* We'll bet the outstanding features . . . the eye-appeal, the buy-appeal of these two new sets . . . whet your appetite for further Farnsworth developments. See your distributor for the new Farnsworth profit story.

### ● The Profit-Picture Looks Good

In the past, the Farnsworth Line has demonstrated that it puts generous profits in the *dealer's* pocket. The *new* Farnsworth Line will continue this Farnsworth *success policy.* See the new models at your Farnsworth distributor's *today.* Get the money-making facts. Or wire, phone or write to FARNSWORTH TELEVISION & RADIO CORPORATION, FORT WAYNE, INDIANA.

\*PRICES F. O. B. FACTORY, SUBJECT TO CHANGE WITHOUT NOTICE



## IT'S GOT "BUY ME" INSIDE AND OUT

This brand-new Tapered Model Portable CT-60. Styled to look like expensive luggage . . . in rich, walnut-toned, durable leatherette. The "table-model" chassis helps give this unit an all-around performance amazing to customers accustomed to ordinary portables.

The 6 tubes operate on a 3-way power supply: AC, DC or batteries (all standard makes). *Tuned R. F. amplifier* and *three-gang tuning condenser* give exceptional sensitivity and selectivity. Change-over switch makes it impossible to drain batteries by mistake. A lot of radio and for a price that opens pocketbooks.

# FARNSWORTH •

MAKERS OF RADIO AND TELEVISION TRANSMITTERS AND RECEIVERS. THE CAPEHART, THE CAPEHART-PANAMUSE AND FARNSWORTH PHONOGRAPH-RADIO COMBINATIONS

# The Oregonian

PORTLAND, OREGON THURSDAY, APRIL 4, 1935

CITY EDITION 12 PAGES FIVE CENTS

Own Ending  
 in Mount Hood... University of Washington...  
 their final master of drama...  
 own dramatic...  
 American Society.

EX. LEASE - NO. 14,783

## One of Hood Climbers Rescued: Rescued Climber Relates Details of His Struggle

BY JAMES LORENTZ

Here is the story of James (Jay) Lorentz, who was rescued Tuesday after having spent three days lost on Mount Hood, as related at the Oregon City...  
 Paul Larson, a man in the staff...  
 on "Spike" and said...  
 now and said...  
 farther. I...  
 k and started...  
 said he was...  
 k dark, and I...  
 bill and broke...  
 as lucky, for when...  
 I was right at the...  
 edge of a steep cliff...

### Mystery of Tracks Cleared by Lorentz

The major mystery of the search for Gerald Herrmann and James Lorentz—the mystery of the footprints that seemed to lead to the north wall of Mount Hood—was cleared up Wednesday night by the survivor, James Lorentz. Rather than...  
 "hello," and I sat right beneath a tree, for I knew...

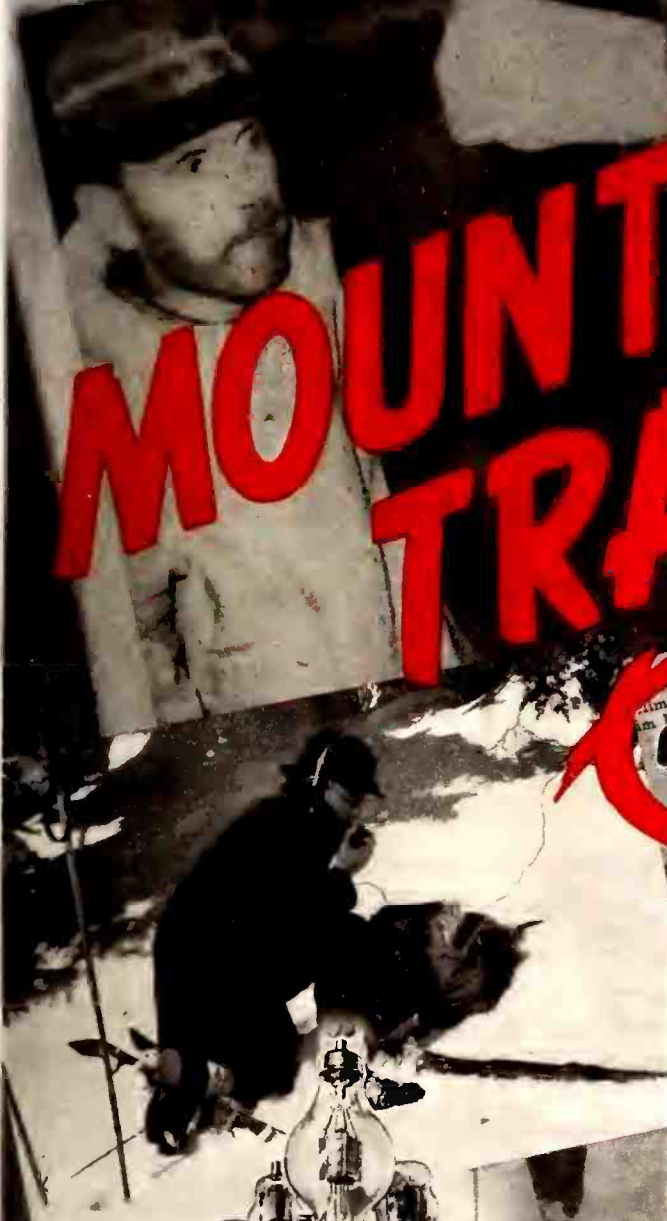

**MOUNTAIN TRAGEDY!**

**WITH RAYTHEON A VITAL FACTOR IN THE RESCUE!**

**RAYTHEON**  
 MAKES THEM ALL

NEWTON, MASS. NEW YORK CHICAGO  
 ATLANTA SAN FRANCISCO

**T**HE thrilling rescue of James Lorentz from the tragic fate which overtook his climbing companion Gerald Herrmann on Mount Hood a year ago next month was another example of the important part radio takes in directing organized work in the National Forests.

It is significant that the U. S. Forestry Service is a steady user of RAYTHEON Tubes. Their engineers have found that RAYTHEONS can be depended upon even for use in portable two-way equipment carried in packs over rough mountain trails for use in EMERGENCIES!

Replacing tubes in home receivers, auto sets and amplifiers may present easier problems, but the same dependable RAYTHEONS are available and cost not one penny more than ordinary tubes.

No wonder the ENGINEERS among Servicemen use them exclusively.

Over 2,000,000 push button radios must be reset for the new frequencies. This is a good time to replace weakened tubes with RAYTHEON and increase your service business in general.

...a searching party...  
 in the snow Wednesday...  
 a sled. They include...  
 Wood. (Jim Nutter...  
 Ralph Had...  
 Mockford left...  
 shelter after...  
 Tuesday after...  
 arrived they...

...found him, Mc...  
 Leuthold, Ralph Wiese...  
 Bill Wood and Paul Livingston...  
 declared as they returned to the...  
 lodge with the notation that they...  
 believed the notation was made...  
 morning before the...  
 reached the top to...  
 "March...

**WORLD'S LARGEST EXCLUSIVE RADIO TUBE MANUFACTURERS**



**"LET'S SEE THE CROSELY!"**

From the day we showed The New 1941 Super SHELVADOR to our Distributors at our Cincinnati meeting, we have had wires, air mail letters, long distance calls from

**BUYERS FOR MAJOR OUTLETS • MANY IMPORTANT DEALERS  
FIRMS SEEKING DISTRIBUTORSHIPS • HOME ECONOMISTS  
FOOD EDITORS OF MAGAZINES**

all hailing Crosley as  
**THE 1941 SMASH SUCCESS**

At the Housewares Show in Chicago, at previews everywhere, they swarm around the Crosley, because this patented, exclusive construction

**SELLS WOMEN AT A GLANCE**

It's America's No. 1 Food Convenience Feature

**TWICE AS MUCH  
FOOD TO THE FRONT**

No other make can have the utility, convenience and quality which the Industry has long sought but never before delivered at any price.

**BIGGER—  
MORE BEAUTIFUL—  
GREATER CONVENIENCE  
and UTILITY than anything  
else in the Industry**

Only Six Popular-Sized, Fast-Selling Models, 4 "Sixes"—2 "Eights"

# SUPER SHELVADOR SPACE IS ALL EXTRA SPACE!

Main food compartment in the "Sixes" measures full 6 cu. ft. exclusive of the door. There's over an extra cubic foot in the Shelvador—a bonus that only a Crosley offers!

In the "Eights" there is actually 9 cu. ft. including the Shelvador!



**Plus a New CROSBY**  
Big Low Priced "6" for only  
**\$99.95\***



The lowest price ever offered for a 6-cubic-foot model with a nationally-advertised name! Packed with traffic-building, promotional power!

Entirely new appearance for a Crosley of this price—with enough features to make this the outstanding value on the market for a "6" of anywhere near this price!

\*Prices slightly higher in the far west

For further information, or on invitation to view the complete line of new models, get in touch with your nearest Crosley distributor. Or communicate direct with factory headquarters—by letter, phone or wire.

**THE CROSBY CORPORATION**  
POWEL CROSBY, JR., PRES. CINCINNATI, OHIO

66  
/  
66

What th—?

Have any idea?

?

What's it  
all about?



**Algebra —? No! Numerology —? No! And not a "Numbers" Game! But it is a sure-fire new money-making BUSINESS Formula!**

**Your RCA Tube Distributor will have the answer soon**

# NEW **ZENITH** 1941 PROSPERITY MODELS

R.G. U.S. PAT. OFF.

**NEW  
BIG  
TABLE MODEL  
VALUE**  
AT AN AMAZING  
NEW LOW PRICE



Illustrated are only 4 of the 14 sensational new 1941 Prosperity models designed for a Smashing Winter and Early Spring Selling Season! More eye value . . . more built-in quality . . . more inherent saleability than you have seen in many a day. A model for selling in each strategic price bracket. Big new console values . . . big new combination values . . . big new table model values . . . big new battery model values . . . priced to give you an attractive profit and an opportunity to pull those old radios out of your prospects' homes. Here is fresh, brand new, fast moving merchandise to give you quick sales right now!



**NEW  
BIG  
RADIO-PHONOGRAPH  
VALUE**  
IN RADIO'S MOST  
IMPORTANT COMBINATION  
PRICE BRACKET

**GET IN TOUCH WITH YOUR  
ZENITH DISTRIBUTOR**  
*Today* HE IS NOW  
SHOWING THESE  
NEW ZENITH  
MODELS

**NEW  
BIG  
VALUE**  
IN RADIO'S MOST  
IMPORTANT CONSOLE  
PRICE BRACKET



**Only Zenith Has This!**

U. S. PATENT NO.  
2164251

The Zenith  
Universal  
Portable  
Radio with  
the Built-in  
Moveable  
Wavemagnet.

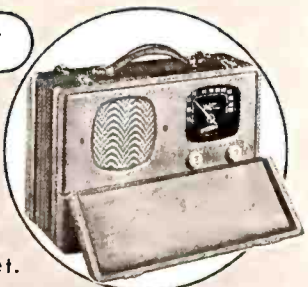

**The Radio That Knows No Season**

ZENITH RADIO CORPORATION CHICAGO, ILLINOIS  
AMERICA'S OLDEST MANUFACTURER OF FINE RADIOS FOR THE HOME

# Sonora - ALL SET FOR '41!



**MODEL KM.** The "Coronet," 5 Tube AC-DC Superhet. Tunes 535-1720 KC. Has built-in "Sonorascope" loop; square Gemloid dial; A.V.C.; PM Dynamic Speaker. Cabinet is molded of Alabaster Catalin, in a choice of three striking trim colors. With carrying handle.  
Size: 9 $\frac{1}{8}$ " x 6 $\frac{1}{4}$ " x 5 $\frac{1}{2}$ "

Yes, SONORA is all set for '41 with a COMPLETE in-demand Start-of-the-Year Line! Here's merchandise you can sell—starting right now—with all the smart styling, all the heads-up engineering, all the top value you've come to expect from SONORA. Plastics, "Gems," wood mantel models, combinations, electric phonographs—SONORA has the best-selling answer for today's market. SONORA for '41, backed by the most desirable Jobber Policy in radio, is Radio's Big Profit Opportunity this new year!



**MODEL LR-147.** The remarkable new SONORA "Triple-Play" Portable. Operates from self-contained batteries, from 110 volts AC or from 110 volts DC. Tunes 535-1720 KC. Superhet circuit features: built-in "Sonorascope" loop; PM Dynamic Speaker; A.V.C.; large Slide-Rule Dial. The open-face carrying case is of striking new design with handsome walnut overlay grille. Finished in attractive brown, with sturdy carrying handles.  
Size 14" x 9 $\frac{1}{2}$ " x 6"

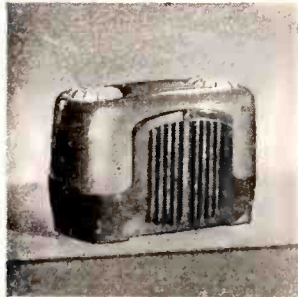

**MODEL KF.** These new "Gems" set a jewel-like note in radio styling! They feature a new plastic design in duotone colors—available in three distinctive 3-color combinations. 4 Tubes. Tunes 535-1720 KC. Has PM Dynamic Speaker. America's most distinctive tiny radio.  
Size: 5 $\frac{1}{8}$ " x 7 $\frac{1}{16}$ " x 4 $\frac{1}{4}$ "



**MODEL KNF-148.** A distinctive 5 Tube AC-DC Phonograph-Radio. Tunes 535-1720 KC. Has built-in "Sonorascope"; PM Dynamic Speaker; Airplane Dial; 9" turntable; Crystal pickup; plays 10" and 12" records with lid closed. Walnut cabinet of exceptional beauty.  
Size: 9 $\frac{1}{4}$ " x 14 $\frac{7}{8}$ " x 11 $\frac{5}{8}$ "



**MODEL KG-132.** The "Brownie"—SONORA's original Personal Portable—still the leader! 4 Tube Superhet. Tunes 535-1720 KC.; built-in "Sonorascope"; PM Speaker. Noted for longer battery life; more power. In beautiful blown plastic case.  
Size: 8 $\frac{1}{4}$ " x 5" x 4 $\frac{1}{4}$ "



**MODEL KXF-95.** 6 Tube AC Radi-Phonograph. Tunes Foreign and domestic bands. Has "Sonorascope," 10-inch Dynamic Speaker; Push-Button tuning. Includes Automatic Record Changer for 10 and 12-inch records. Massive walnut console. 36" x 32" x 15". The year's Big Hit in a modestly-priced Combination instrument.

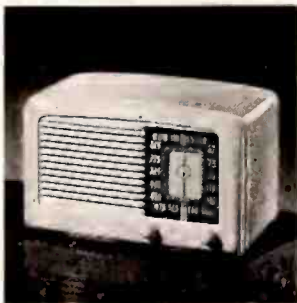

**MODEL KT.** The "Cameo"—a 1941 SONORA original Beauty Radio! Available in Ivory or Walnut plastic. 5 Tube AC-DC Superhet tunes 535-1720 KC. Has built-in "Sonorascope"; PM Dynamic Speaker; A.V.C.; extra-large Airplane Dial. Size: 10 $\frac{3}{4}$ " x 6 $\frac{3}{8}$ " x 6 $\frac{1}{2}$ ". An outstanding SONORA Best Seller design triumph.



**MODEL LD-93.** 5 Tube AC-DC Superhet. Tunes two full bands for Foreign and Domestic reception. Has built-in "Sonorascope"; large Clock-type Dial; PM Dynamic Speaker; A.V.C. Presented in a striking-looking walnut wood cabinet. 12 $\frac{5}{8}$ " x 7 $\frac{1}{8}$ " x 6 $\frac{3}{8}$ ". Designed to meet America's radio requirements for 1941.

## JOBBERS... WRITE FOR COMPLETE DETAILS...

Send for SONORA's impressive 1941 brochure—"Listen America"—that illustrates and describes the 1941 "Clear as a Bell" complete home entertainment line. And write for the new SONORA booklet describing the only successful "Jobber Plan for Profitable Radio Selling"—a significant milestone in radio merchandising.



**SONORA RADIO & TELEVISION CORP.**

2626 WASHINGTON BLVD.  
CHICAGO, ILLINOIS



# RADIO *and Television* TODAY

## RADIO ON THE UPTAKE

All over the nation, production is speeding up, employment is coming back, and new buying power is on the march!

Radio men report that this advance wave of Defense prosperity is now beginning to reach radio channels—in full force! Already it is reflected in new purchases of radios, phonograph units, records, portables, service jobs, and electrical appliances. Meanwhile the more aggressive radiomen are going out after particular people who have new jobs or new payroll increases. They are selling where there's new-found "cash-in-pocket."

How this Defense upsurge has worked out in one typical American community and its effect on local radio outlets, is described in detail in following pages. Here is a lesson for every community and for radio men everywhere.

Radio prosperity, like all prosperity, goes to the man who goes after it!

### "RADIO'S MOVING DAY", MARCH 29TH

Another great impulse to radio and service sales is handed to radio men in the FCC's order changing the channels of 795 of the country's broadcast stations on March 29.

This means that 11 million push-button sets will need resetting after March 29. So the door will be opened to homes everywhere for receiver inspection and overhauling, and for tube and parts replacements and even receiver sales.

What to tell the customer, how to reset different circuits, and how to cash-in on the results of this great March 29 "Moving Day", are all outlined in this issue—with more details to come next month.

In this great open-season for servicemen, caution must be observed that button resetting and overhauling be done carefully and conscientiously. Radio will be given a black eye locally if this opportunity is seized by a few to go "off-side" in straight-arm selling or bad servicing.

Every qualified serviceman will use it as a great opportunity for real service to the public, in restoring good reception after the stations shift March 29.

EDITOR Orestes H. Caldwell;  
PUBLISHER M. Clements;  
Managing Editor, Darrell Bar-  
tee; Merchandising Editor, H.  
L. M. Capron; STAFF, E. T.  
Bennett, N. McAllister, G. H.  
Mayorga, William E. Moulic,  
M. H. Newton, R. A. Neubauer  
B. V. Spinetta, R. Y. Fitz-  
patrick, 201 N. Wells St.,  
Chicago, Ill.; CALDWELL-  
CLEMENTS, INC., 480 Lex-  
ington Ave., NEW YORK,  
N.Y. Telephone PLaza 3-1340.  
Copyright 1941. Member Aud-  
it Bureau Circulations. Vol.  
7, No. 2. February, 1941.

# TODAY'S TRENDS

## Retail Sales Speed Up

General retail sales in all parts of the country are reported as 5 to 7 per cent ahead of corresponding sales for a year ago, with the national average running somewhere about 6 per cent increase.

Defense speed-up has built up employment rolls and pay-roll increases, and these improved conditions are beginning to be shown in sales of radios and electrical appliances, one of the first directions in which new purchase money goes.

## To Explain Re-Allocation Benefits

To explain to the radio audience why the coming March 29 Broadcast Re-allocation was necessary, and why it will improve reception for both rural and city listeners, Editor O. H. Caldwell of RADIO TODAY will tell listeners about the great shift of 795 radio stations, during his regular "Radio Magic" program, Friday, February 21 at 7:15 p.m. EST (6:15 CST) on WJZ and NBC's Blue Network.

"Radio Magic" programs at the same time on following Friday evenings, will give further timely hints to radio listeners in connection with the re-allocation shift, advising how to utilize the services of radio men

to reset push buttons, check tubes, parts and antennas, and eliminate electrical interference.

## RMA Making Defense Survey

Under the direction of Bond Geddes, executive vice-president, the Radio Manufacturers Association is surveying by questionnaire the plants of radio manufacturers.

While the questionnaire is brief, it is carefully drafted to bring out all of the essential facts and will give a complete picture to the national defense organization and government officials, as well as the industry, regarding productive capacity for the national defense program. The survey is designed also to assist in the sub-contracting program now being urged by the government.

## Twelve Million Radios in 1940?

Previous estimates regarding the number of radio sets made and sold by American manufacturers during 1940, appear to have been on the side of conservatism. Now that more complete figures for the year are available, revised estimates indicate that approximately 12,000,000 sets were sold, including exports, automobile radios, and all types of sets.

By months. (with December esti-



Paul V. Galvin, Motorola president, now becomes chairman of RMA's special committee on National Defense Procedure.

mated as equalling November) here are the totals for 1940:

January	870,000
February	800,000
March	800,000
April	700,000
May	770,000
June	1,060,000
July	900,000
August	1,100,000
September	1,100,000
October	1,300,000
November	1,300,000
December	1,300,000

Total 12,000,000

This is an increase of 14 per cent over the 10,500,000 total sets sold during the previous year of 1939.

## Tube Prices Go Up

Early this month, the advancing prices of radio's raw materials became a very tangible factor in the boost of list prices. Throughout the tube manufacturing industry a 5 cent average increase in tube lists became effective, with an appropriate lift in wholesale prices.

It was pointed out that since tube prices had already been pared and repaired until the profit margins were smaller and smaller, that any rise in the cost of making them would be sensitively reflected in list prices.

## Court Upholds Stamp Ban

The 1939 Wisconsin trading stamp law, which prohibits the issuing and redeeming of trading stamps with the sale of fair trade merchandise when redemption of the stamps would bring the net price below the producers' es-



While Philco continues radio promotions on "music on a beam of light", the firm also starts the refrigerator season with '41 convention orders double last year. Jubilant officials here, l. to r., James T. Buckley, president; Larry E. Gubb, executive vice-president, and Stuart Falk, eastern division manager, Buffalo.

established minimum price, was held constitutional last month by the state supreme court.

The plaintiff stores were sustained in their contention before the lower court that the law was "unconstitutional class legislation" by Circuit Judge Gustav G. Gehrz. His opinion is now overruled by the high court. The supreme court pointed out that it had previously upheld the state fair trade act and that the trading-stamp law related directly to that act and consequently the stamp measure was not "indefinite and uncertain," as the plaintiff stores had claimed.

The decision stated that "this chapter (trading stamp law) was designed to fortify the earlier act and to prevent what the legislature considered to be a form of price cutting.



J. H. Rasmussen is the new manager of Crosley Corp.'s radio division. He'd previously held key sales posts with Zenith, Grunow, and others.

### FM Plans Go Ahead

More than 30 construction permits are now approved by FCC for new frequency-modulation transmitters, while some 56 FM applications still await the attention of the Commission.

Zenith Radio Corporation, recipient of a construction permit for an FM station in Chicago, has signed a nine-year lease with Chicago's 600-foot Field Building. The agreement becomes effective May 1 when Zenith's 50,000-watt FM transmitter starts operation on a commercial basis as W51C. Meanwhile, WGN is reported rushing completion of its FM installation on the 25th floor of the Tribune Tower. Both stations will cover a wide area of 10,800 square miles in which some 4,500,000 persons reside.



First capsule for space at the Radio Parts National Trade Show, June 10-13, is drawn by Helen Staniland, Quam-Nichols vice-president, who hands it to Show committeeman E. S. Riedel of Raytheon. Irving Kahan, left, of Sprague Products, finds the number to be that of John Rider, radio publisher.

### The Stars of the Radio Business

The comparative popularity of the various programs on the air is of everlasting importance to the men who are selling sets. If a retailer does not know which are the favorite programs, he is apt to leave a ranking comedian or a great singer out of his sales talks.

Each year, the New York *World-Telegram* polls the radio editors of the nation for their program preferences. The paper has released the results of its tenth such poll, and the vote shows that the top show is still Jack Benny, with Fred Allen second,

Information Please third, Bob Hope fourth, and Fibber McGee & Molly fifth.

The much-dialed Mr. Benny was also named the leading comedian. Other broadcasts picked in the poll included Information Please as the best quiz show, Guy Lombardo as the No. 1 orchestra, Bing Crosby as the male singer, Kate Smith as the girl singer, Bill Stern as the top sport announcer, Raymond Gram Swing as the favorite commentator, Lux Radio Theater as the best dramatic program, Irene Wicker as the leading entertainer for youngsters, Lily Pons as the top classical singer, Toscanini as the symphonic conductor, and Dinah Shore as the "new star."



Stromberg-Carlson's merchandising plans, in which FM plays big part, get the once-over by general sales manager Lloyd Spencer, with book, and Jenkins Music execs. L. to r., Stanley Manson, SC Kansas City mgr.; Paul Jenkins, Music Co. president; Mr. Spencer; and Kenneth Gillespie, Jenkins wholesale division manager.



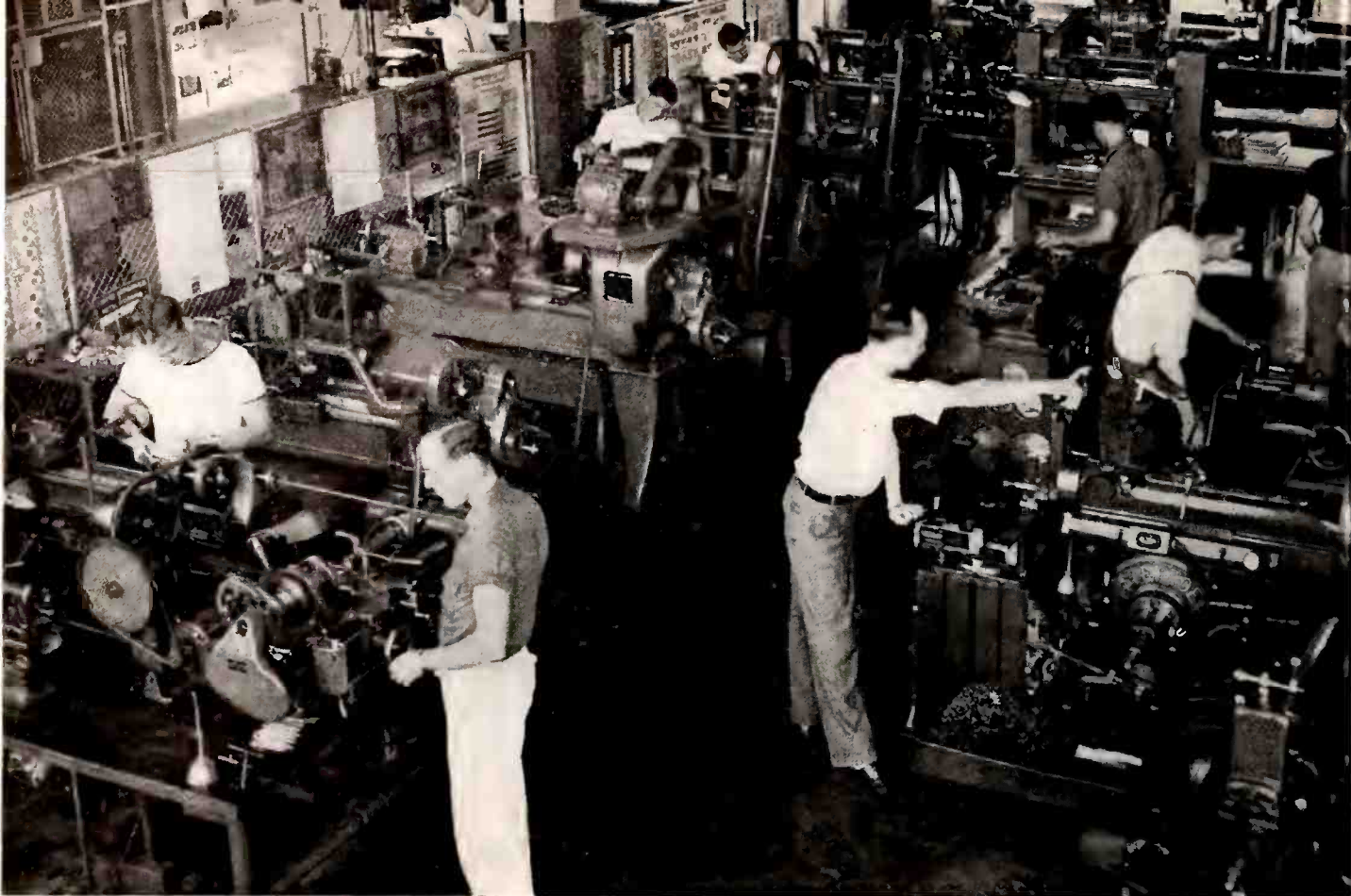

Courtesy Lancaster Sunday

# DEFENSE JOBS SPEED

## RADIO TODAY SURVEYS A PENNSYLVANIA CITY TO CHART THE RADIO MAN'S APPROACH TO NEW BUYING POWER

An extra hum, rising from the factories where National Defense products are being manufactured, is now heard in many U. S. cities.

The nation is re-arming with a red-white-and-blue vigor, and it's beginning to have an impact on radio selling. More people are looking forward to spending more money.

Radio men want to be dead certain that they get their best foot forward, in their advance toward greater sales volume. They are eyeing the nature and the extent of the new buying power, so that they may draw the extra buyers promptly and efficiently to their stores.

All this activity, as it starts to change the scene in a town of average size, has been analyzed by *RADIO TODAY*. The editors have personally surveyed the city of Lancaster, Pa., where some 61,284 folks live and are



The stream of shoppers on N. Queen St. in Lancaster shows that incomes are ship-shape. Radio men here are taking action to attract their share of buyers.

helping to re-arm. The city has yielded its re-employment and payroll figures, its radio merchandising plans, and its considered views on "wanted" merchandise for the new prosperity period.

For this report, the magazine's reporter took the trouble to interview, in Lancaster, seven radio dealers, two radio jobbers, the local Manufacturers' Association, the Chamber of

Commerce, three of the leading manufacturers, the local Unemployment Agency, two bankers, the local Defense committeeman, the town newspaper, and a string of citizens.

It was found that 15 manufacturers in Lancaster are involved in defense orders, or sub-contracts. The estimate made by C. M. Woolworth, a defense spokesman for the manufacturers there, that total work may reach \$6,-

000,000, and that about 60 per cent of this will be paid into the hands of workers. This is extra buying power of important size.

Down town, it was revealed by J. B. Cannon, the radio man at the J. H. Troup Music House that business was running about 66 per cent over last year. And the report from Paul Eshelman, prominent radio jobber, was that his volume was hitting a pace of from 40 to 50 per cent over last year.

At the left, machine shops in Lancaster are seen running at the new "defense" tempo. Below, a view of the Armstrong Cork Co. suggesting that hundreds of prosperous workers are running the plant full blast.



However, it cannot be said that these jumps in radio sales are totally and directly due to the defense activity in Lancaster. The full effect of re-employment and payroll increases are still to be felt. But radio men agree that a general tone of improved business is already there, and that it's time to think of the methods for handling it.

Lancaster, like many other American cities whose industries are predominantly average-sized and well diversified, will never let itself in for a terrific "boom" as Government orders rush in. The town is located in one of the richest agricultural counties in the U. S. and the local income is neatly balanced between farm products and industrial wages.

Yet this type of city is in position to make more than a dozen different products for Uncle Sam. Current orders are for parachute silk, aircraft watches, army socks, bearings, forges, coat hooks, life preservers, army cots, shells, mosquito netting, anchors, wood-working machines, buoys, asbestos cloth, padlocks, etc.

And the plants are humming, whether it's due to generally improved business or defense orders. At the Hamilton Watch Co., the number of employes has increased from

Action in Lancaster, Pa.,  
Illustrates how

## IN TOWNS ALL OVER AMERICA, RADIO MEN ARE—

- Selling as much as 66% more than they sold at this time last year.
- Asking old customers for leads on people who have new jobs or pay increases, as a result of Defense work.
- Planning to stock up on new merchandise appropriate for the new market.
- Checking all serviceman contacts for names of those re-employed by local factories.
- Keeping a record of newcomers to town.
- Strengthening their regular promotion (newspaper ads, direct mail, window displays, etc.)
- Placing more receivers on demonstration in public places, with "where to buy it" cards.

1,758 on Jan. 1 to 1,981 on Jan. 24. At the Armstrong Cork Co., where 3 in. anti-aircraft, and 75 mm. explosive shells are ordered, the firm takes on 100 additional workers at a clip. Armstrong regularly hires nearly 5,000 workers. De Walt Products Co., which deals in wood machines, is planning to double its number of employes. At the Animal Trap Co. of America, near Lancaster, where Defense committeeman Woolworth is president, defense orders so far amount to \$328,000 and the firm has bid on \$935,000 worth. For production peaks, this company hires an extra 100 or so workers.

### WORKERS CAN BUY

All this is expected to boost the \$50,000,000 annual retail business regularly done by Lancaster business men, to a new figure for 1941. And as the city's normal number of employes grows from 27,000 to a fresh total, the other economic element in the area, the farmers, will be benefited. The local farmers now make a practice of bringing their products to Lancaster's five markets, where they sell direct to townpeople. As the city folks' incomes increase, these markets improve, and farmers are in better position to buy more radio products.

Now, what are radio men *doing* about the pickup in business?

Radio man Arthur C. Brown at Kirk Johnson's, who is working now against a background of "a very nice radio business," is planning some new promotions of a general nature, particularly on higher priced sets. More salesmen will be added. He believes that radio volume in 1941 will be

(Continued on page 24)

# RADIO SALES



Out of Lancaster's humming activity comes the radio prospect. Here, G. W. Douglas of Douglas Radio & Television is ready with a console demonstration.



000,000, and that about 60 per cent of this will be paid into the hands of workers. This is extra buying power of important size.

Down town, it was revealed by J. B. Cannon, the radio man at the J. H. Troup Music House that business was running about 66 per cent over last year. And the report from Paul Eschelman, prominent radio jobber, was that his volume was hitting a pace of from 40 to 50 per cent over last year.

At the left, machine shops in Lancaster are running at the new "defense" tempo. Below, a view of the Armstrong Cork Co. suggesting that hundreds of prosperous workers are running the plant full blast.

However, it cannot be said that these jumps in radio sales are totally and directly due to the defense activity in Lancaster. The full effect of re-employment and payroll increases are still to be felt. But radio men agree that a general tone of improved business is already there, and that it's time to think of the methods for handling it.

Lancaster, like many other American cities whose industries are predominantly average-sized and well diversified, will never let itself in for a terrific "boom" as Government orders rush in. The town is located in one of the richest agricultural counties in the U. S. and the local income is neatly balanced between farm products and industrial wages.

Yet this type of city is in position to make more than a dozen different products for Uncle Sam. Current orders are for parachute silk, aircraft watches, army socks, bearings, forges, coat hooks, life preservers, army coats, shells, mosquito netting, anchors, wood-working machines, buoys, asbestos cloth, padlocks, etc.

And the plants are humming, whether it's due to generally improved business or defense orders. At the Hamilton Watch Co., the number of employes has increased from

Action in Lancaster, Pa., illustrates how

## IN TOWNS ALL OVER AMERICA, RADIO MEN ARE—

Selling as much as 66% more than they sold at this time last year.

Asking old customers for leads on people who have new jobs or pay increases, as a result of Defense work.

Planning to stock up on new merchandise appropriate for the new market.

Checking all servicemen contacts for names of those re-employed by local factories.

Keeping a record of newcomers to town.

Strengthening their regular promotion (newspaper ads, direct mail, window displays, etc.)

Placing more receivers on demonstration in public places, with "where to buy if" cards.

1,758 on Jan. 1 to 1,981 on Jan. 24. At the Armstrong Cork Co., where 3 in. anti-aircraft, and 75 mm. explosive shells are ordered, the firm takes on 100 additional workers at a time on 100 additional workers at a clip. Armstrong regularly hires nearly 5,000 workers. De Walt Products Co., which deals in wood machines, is planning to double its number of employes. At the Animal Trap Co. of America, near Lancaster, where Defense committeeman Woolworth is president, defense orders so far amount to \$328,000 and the firm has bid on \$335,000 worth. For production peaks, this company hires an extra 100 or so workers.

### WORKERS CAN BUY

All this is expected to boost the \$30,000,000 annual retail business regularly done by Lancaster business men, to a new figure for 1941. And as the city's normal number of employes grows from 27,000 to a fresh total, the other economic element in the area, the farmers, will be benefited. The local farmers now make a practice of bringing their products to Lancaster's five markets, where they sell direct to townpeople. As the city folks' incomes increase, these markets improve, and farmers are in better position to buy more radio products.

Now, what are radio men doing about the pickup in business?

Radio man Arthur C. Brown at Kirk Johnson's, who is working now against a background of "a very nice radio business," is planning some new promotions of a general nature, particularly on higher priced sets. More salesmen will be added. He believes that radio volume in 1941 will be

(Continued on page 24)

# DEFENSE JOBS SPEED RADIO SALES

## RADIO TODAY SURVEYS A PENNSYLVANIA CITY TO CHART THE RADIO MAN'S APPROACH TO NEW BUYING POWER

An extra hump, rising from the factories where National Defense products are being manufactured, is now heard in many U. S. cities.

The nation is re-arming with a red-white-and-blue vigor, and it's beginning to have an impact on radio selling. More people are looking forward to spending more money.

Radio men want to be dead certain that they get their best foot forward in their advance toward greater sales volume. They are eyeing the nature and the extent of the new buying power, so that they may draw the extra buyers promptly and efficiently to their stores.

All this activity, as it starts to change the scene in a town of average size, has been analyzed by RADIO TODAY. The editors have personally surveyed the city of Lancaster, Pa., where some 61,284 folks live and are



The stream of shoppers on N. Queen St. in Lancaster shows that incomes are ship-shape. Radio men here are taking action to attract their share of buyers.

helping to re-arm. The city has yielded its re-employment and payroll figures, its radio merchandising plans, and its considered views on "wanted" merchandise for the new prosperity period.

For this report, the magazine's reporter took the trouble to interview, in Lancaster, seven radio dealers, two radio jobbers, the local Manufacturers' Association, the Chamber of

Commerce, three of the leading manufacturers, the local Unemployment Agency, two bankers, the local Defense committeeman, the town newspaper, and a string of citizens.

It was found that 15 manufacturers in Lancaster are involved in defense orders, or sub-contracts. The estimate made by C. M. Woolworth, a defense spokesman for the manufacturers there, that total work may reach \$6-



Out of Lancaster's humming activity comes the radio prospect. Here, G. W. Douglas of Douglas Radio & Television is ready with a console demonstration.



# MAR. 29

## What to Tell Your Customers. Why the Re-Allocation Was Necessary. More Dollars from Resetting Push-Buttons and Overhauling Sets.

Next month most of the broadcasting stations of the United States will move to new wavelengths.

This means that after March 29, most stations will be found at new positions on all radio dials.

For some stations the shifts will be slight. For a very few stations there will be no change of position at all. But certain stations will have to make wide jumps, half way across the dial (see accompanying table).

On *dial-type* radios, after the March 29 "Moving Day," most stations regularly heard in your town will be found *somewhere near* where they were before—usually higher.

### MAKE CLEAR TO THE PUBLIC THAT—

On *push-button* radios, however, the buttons will have to be reset for all stations that are moved at all. This will mean calling in a competent radio man—to reset the push-buttons and to re-tune them squarely on the new station positions—so that the listener may once again get clear undistorted reception.

This March 29 change in station positions will bring improved reception, especially to those who live in

rural districts. City reception is also expected to be improved. And suburban reception will undoubtedly be as good as before.

Besides improved reception, the radio-set owner can also take satisfaction in having a part in a "good neighbor" gesture to our fellow Americans to the South, as Uncle Sam "moves over," slightly, to make room in the ether for Mexico and Cuba!

For the principal result accomplished by the coming reallocation will be to provide special channels for the big Mexican and Cuban stations which have developed during the years since the last broadcast allocation was made in 1928 by the original Federal Radio Commission.

You see, there were no Mexican or Cuban stations of any power when the existing set-up was originally made 12 years ago. At that time the small stations then operating "south of the border" could be easily accommodated in the same channels as U. S. and Canadian stations because of the blanketing effects of tropical static. In the last few years, however, Mexico and Cuba began to acquire more and more—and larger and larger—broadcasting stations.

Mexico, for example, today has the most powerful transmitter in operation in the Western Hemisphere—a station of 350 kilowatts power—seven times as powerful as the largest transmitter now authorized to operate in the U. S.

As these big stations South of the border came on the air, their operators, finding no assigned space for them in the radio spectrum, sandwiched them in between U. S. "clear-channel" stations which, like all U. S. stations, are on even-10-kilocycle assignments. Some of the foreign high-power stations thus took channels with 5-kilocycle designations, half way between. Each such interloper thus spoiled reception of *two* important U. S. broadcast stations, over wide areas. In other cases, the intruding stations came squarely on U. S. channels, producing bad heterodyne interference all over the United States, in regions 50 miles or more from the transmitter. So bad had this interference from across the border become, in the radio sets of rural and small-town dwellers all over the United States, that "something had to be done."

### INTERNATIONAL CONFERENCE

So a conference of the principal North American nations was called at Havana a couple of years ago, and efforts were made to provide a sound engineering allocation of the 1300 broadcast stations on the North American quadrant, just as if all

---

## Use the Pushbutton Change, March 29th, To Sell—

Tubes, Parts  
 Antennas  
 Noise-elimination filters  
 Overhaul jobs  
 Vibrators  
 Extra radios  
 Portable radios  
 Full-BC-band radios (550-1600 KC)  
 Record-players and records  
 Electrical appliances

---

# BIG BROADCAST SHIFT

1300 stations were under one single authority, instead of being operated by five nations, each with sovereign rights to all the wavelengths.

The Canadian, Mexican and Cuban stations, of course, have only the same ether to work in as our U. S. stations. And being sovereign nations, Canada, Mexico, Cuba and the rest feel that they have just as much right to use the whole broadcast band of 105 channels as we have.

Of course, if each nation insisted on its sovereign right to use all 105 channels of the broadcast band for its own "national" stations, chaos and confusion would result throughout the whole broadcast band, and listeners everywhere on the North American continent would suffer intolerable interference. Nobody would then be able to get good radio reception.

## RE-ALLOCATING 1300 STATIONS

So an engineering allocation was made by an international committee of radio engineers to provide for all the 1300 North American broadcast transmitters—employing engineering standards of good service similar to those worked out by the Federal Communications Commission.

That is, exclusive channels were to be provided for wide coverage of rural and isolated areas. And when stations were to be assigned to share the same channel, adequate separation of distance was to be provided to prevent interference in each other's service areas.

Under the broad international plan, Canada gets six exclusive channels, Mexico gets six, Cuba one, and the U. S. more than 40. Other channels are set up for high-power sharing between two nations, at distance separations which will safeguard service to each.

Under the reassignments the United States has had its number of channels increased from 44 to 59, and it can use 15 additional channels under certain restrictions set out in the Treaty. On the other hand, its number of regional channels has been reduced from 42 to 41.

## GET READY TO GO AFTER BUSINESS

These many shifts in broadcast station frequencies are scheduled to be carried out on Saturday, March 29, at 3 a.m.

Radio dealers and radio service men should at once make plans to reach listeners with push button sets, to make these push button changes—to

make sure that the job is done right and that the set owner, after March 29, will get the maximum volume and quality out of his favorite stations in their new positions.

If the resetting is not done correctly, the listener may get badly impaired reception after March 29, and lose the full musical quality and crispness of voice announcements, news bulletins and dramatic presentations—if not lose them altogether.

## CHECK TUBES, PARTS, ANTENNAS

And while push buttons are being reset, the service man should check tubes to see whether some may not be worn out and giving impaired reception.

The service man too should check the antenna—gateway to all radio reception. If the set has an outdoor antenna, see whether winter storms,

sleet and wind have impaired its pick-up qualities. If an indoor antenna, see if it is really adequate to bring good reception, without also bringing in a lot of electrical interference. And if a loop antenna is being used see that it is turned correctly for the stations most wanted.

Check over volume controls and condensers, for noisy and worn-out parts. And if the customer is suffering electrical interference, apply the necessary remedies.

A splendid new period of radio reception is before American listeners as the result of the reallocation of March 29—Radio's "Moving Day." But you will want to plan now to be ready to do your part in going after the increased business which will result by putting customers' push button radios in first class operating condition for the new radio set-up.

## Cash In On the Big Push-Button Change

Follow up all owners of push-button receivers, (including auto-radios).

Reset push-buttons.

Check their tubes.

Look over antennas.

Check noisy parts.

Leave new radio-sets on trial with good prospects.

Eliminate electrical interference.

Collect your money.

## HOW BROADCAST STATIONS WILL BE SHIFTED

Comparison of Old and New Channels Under Reallocation Ordered by Federal Communications Commission for March, 29th, 3 a. m.

Present	New	Present	New	Present	New	Present	New
550	550	*	840	1110	1140	1360	1390
560	560	850	870	1120	1150	1370	1400
570	570	860	880	1130	1160	1380	1410
580	580	870	890	1140	{1070	1390	1420
590	590	880	910		{1170	1400	1430
600	600	890	920	1150	{1180	1410	1440
610	610	900	930	1160	{1170	1420	1450
620	620	*	910		{1190	1430	1460
630	630	920	950	1170	{1200	1440	1470
640	640	930	960		{ 940	1450	1480
650	650	940	970	1180	{1000	1460	1500
660	660	950	980		{1030	1470	1510
670	670	*	960		{1130	1480	1520
680	680	970	1000	1190	{1210	1490	1530
*	690	980	1020	1200	{1230	1500	1490
700	700	990	1030	1210	{1240	*	1510
710	710	1000	1040	1220	{1250	*	1520
720	720		{ 690	1230	{1260	1530	1590
730†		1010	{ 740	1240	{1270	1540†	—
740	750		{ 990	1250	{1280	1550	1600
750	760		{1050	1260	{1290	*	1560
760	770	1020	{1060	1270	{1300	1570†	—
770	{ 780	*	{1030	1280	{1310	1580†	—
	{1110	1040	{1080	1290	{1320	*	1590
780	790	1050	{1070	1300	{1330	*	1600
790	810	1060	{1090	1310	{1340		
800	820	1070	{1100	1320	{1350		
810*	830	1080	{1110	1330	{1360		
820	840	1090	{1120	1340	{1370		
830	850	1100	{1130	1350	{1380		

\*Formerly not assigned in U.S.  
†Not assigned in U.S.

# WHEN YOU CHANGE PUSH-BUTTONS—



1. At left. Take along the newest table model for a demonstration while checking and adjusting the old set. Plan to leave the set (a push-button model adjusted for the new frequencies) if it is necessary to take the old set to the shop for repairs. Many extra sales will be made when the set finds its place in the home.

---

## THINGS TO DO . .

Take new set to sell as "extra" home receiver.

Test and replace all weak and old tubes.

Clean chassis, speaker. Replace old pilot lamps.

Re-set push-buttons for peak performance.

Eliminate noise with new antenna, line filters, etc.

Sell complete overhaul job on old set.

---

At left. Check the tubes in the old set before re-adjusting push-buttons. Replacing any weak ones first will insure the job on re-alignment. Let the customer see the testing and installation of new tubes.

3. Below. Carefully peak all push-button adjustments for best reception after allowing set to warm-up. On capacity types, try to put station on button that can be tuned near maximum capacity position. See pages 40 and 41 for the adjustments on various push-button mechanisms.



5. Above. Clean-up the old chassis, speaker cone, voice coil, and cabinet. In bad cases, the cleaning should be done before the adjustments are made. Check speaker connecting cable, antenna and ground leads, pilot lamps, etc. for a complete and satisfactory job.

6. Below. When the set needs a shop check-up, sell the plan of improving the quality, and performance with new tubes, new speaker, filter condensers, re-alignment or such parts and operations needed. (Photo shows serviceman Marvin Kaplan, Paramount Radio, 765 3rd Ave. New York City.)



At right. Noise elimination is another profit opportunity. Start with the antenna and check for loose connections, condition of wire, etc. Test aerial, ground, and power line for noise and apply correct remedy.



As shown in photo is 1941 Crosley Radio City Products Model 803 tube-set later shown in 2.

# HALF THE CARS . . .



radio installed in your own car. Tell the owner your story. Offer to fix him up while his car is in its downtown parking place—tell him you'll pick it up, install the set and return it, all radio equipped.

Whenever you see a driver sitting in a radio-less car, step up to him, open a conversation, and ask him if he wouldn't be interested in listening to news and music as he sits there waiting.

## CARD REMINDERS IN EVERY RADIO-LESS CAR

And have cards or folders printed to put into cars without radios which are parked at the curb all around your neighborhood. (Don't put the cards under the windshield wiper—that will irritate your prospect when he has to remove card in order to drive away.) Put the card on the front seat, where he can pick it up and read it at leisure.

# . . . NEED RADIOS

## BIGGEST UNSATURATED MARKET FOR SETS TODAY IS "ON WHEELS"

What is the greatest unsaturated market for radio left today? Undoubtedly, *automobile radio*.

Just look out the window and watch the prospects for car-radios go by!

Half the cars you see pass are real prospects for radio sales.

Half the cars you see parked along the curb—or in any parking lot—have owners who *want* auto-radios right now, but "haven't got around to it."

A lot of car owners, of course, have auto-radios already.

And those who have 'em wouldn't do without 'em. (This is proven by the fact that second-hand auto radios are scarce as hen's teeth.)

### EIGHT MILLION HAVE 'EM

Of all the cars on the road, taking the country as a whole—8 million cars or about one-third the total already are radio equipped. They aren't prospects for radio set sales, now, it is true (but they are prospects for radio service maintenance and repairs.)

Then there are a lot of old cars too far gone to be prospects for radio. Cross these out, of course.

But you will find that left as real prospects—after subtracting the cars radio-equipped *and* the hopeless jalopies—are about half the cars in regular use.

Ask these owners why they haven't

a car radio. Hear the answers:

"Oh yes, I've been intending to get a radio for my car but I just haven't gotten around to it."

### WHAT CAR OWNERS SAY

"It takes a lot of time to put one in, I suppose, so, though I wanted a radio, I haven't bothered."

"I didn't know just who to go to, to get a car-radio installed."

"Nobody ever offered to sell me a car-radio!"

So here's the big opportunity for sales, installation and repairs waiting on a silver platter for radio men in every town.

Hundreds of people within walking distance of your shop this very minute have a half-formed desire to have an automobile radio. They realize "it would be nice to have a radio in our old bus." But they don't know just how to go about getting it. And they don't know who to go to.

So there's your cue, Mr. Radio Man.

### GO OUT AND TELL 'EM

You go to them. Explain how easy it is to install a car radio—how little it costs to have all the enjoyment of news and music as they motor.

Whenever you see a garage, make a call at that house with a sample car

Watch for a time when the car manufacturers are plugging their new models in big-scale ads in your local newspapers, and make your auto set announcements in the same issues. (Most of the new cars may be radio-equipped, but anyway the interest in driving conveniences will be at a peak.)

Arrange to distribute auto radio fliers at places where large numbers of cars are parked . . . football fields, race tracks, etc.

Start with the "noise" aspect of car listening, in some of your promotions, both to emphasize the quality of your units, and to get away from the usual accent on price.

### PUBLIC DEMONSTRATIONS

Demonstrate your car radio on downtown streets when news events, special speeches or important events or baseball or football games are being broadcast. People will be interested in stopping to listen. And have a sign with your name and address, and a reminder—"A radio like this installed in your car for \$ . . . . Ask us about it.

Remember, *one car out of every two* that you see, is a hot prospect for a car-radio this spring.



Get in on the **GOLD RUSH!**

# RCA Victor GOLD SEAL PROMOTION

Is Your Golden Opportunity  
to Make More Money **NOW!**



Practically the entire 1941 line of RCA Victor Radios and RCA Victrolas is included in this special campaign which enables you to offer your customers special values for limited time only. Act now! Get full details and sales-making promotional material from your RCA Victor distributor today!



## RCA VICTROLA MODEL V-300

From the distinguished beauty of its cabinet down to the tiniest part in its chassis, this instrument is real quality. Among its scores of outstanding sales features are Exclusive RCA Victor Tone Guard . . . Automatic Record Changer for 10" or 12" records . . . Record Storage Space in cabinet . . . 10 RCA Victor Preferred Type Tubes plus Magic Eye . . . American and improved Foreign Radio Reception on four wave bands . . . Overseas Dial . . . Electric Tuning for eight stations . . . 20 watts output . . . 15-inch Super-sensitive Electrodynamic Speaker . . . 2 built-in Antennas, one for domestic, one for foreign programs. And at its special Gold Seal Promotion price you'll do a bang up business.

In Canada, RCA Victor Co., Ltd., Montreal . . . Trademarks "Magic Eye," "RCA Victor," and "Victrola" Reg. U. S. Pat. Off. by RCA Manufacturing Co., Inc.

March 29  
Wavelength-  
Changing Time is  
TUBE-SELLING  
TIME!  
RCA Victor  
Preferred Type  
Radio Tubes



## RCA VICTROLA MODEL V-205

Thousands have been sold—and thousands more will be sold as a result of this Gold Seal Promotion. So, be in on the Gold Rush from the very beginning. This instrument has the sales features that mean more business for you. They include RCA Victor Tone Guard . . . Gentle-Action, Automatic Record Changer for 10" or 12" records . . . 9 RCA Victor Preferred Type Tubes . . . American and Foreign Radio Reception on 3 wave bands . . . Electric Tuning for 6 stations, and many others.

Here are 2  
of the many  
**GOLD SEAL SPECIALS**  
you'll be able to offer  
at highly attractive  
prices that mean  
**BIG VOLUME**



# RCA Victor

RCA MANUFACTURING COMPANY, INC., CAMDEN, N. J.

A SERVICE OF THE RADIO CORPORATION OF AMERICA

# RADIOS FOR SPRING SALES

*New receivers variously styled to attract more buyers during current peak in radio listening.*



**Philco 7-tube portable**

★ Model 844T seven-tube portable uses triode noise reducing mixer tube. Operates from batteries or AC-DC line. Has two IF stages. Solid walnut cabinet has novel roll-up cover for dial space. Philco Radio and Telev. Corp., Tioga and C St., Philadelphia, Pa.—RADIO TODAY.

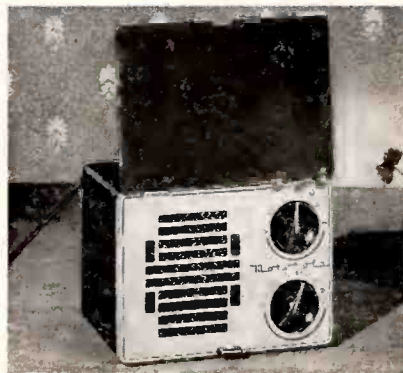

**Motorola 3A5 Playboy**

★ AC-DC battery personal radio weighs six pounds, uses 5 tubes. Automatic change-over switch selects batteries or power line. Uses 4 of the miniature tubes, a 67½ volt B battery, and 5 standard flashlight cells for the A supply. Size, 6¼ x 4½ x 5¼. Galvin Mfg. Corp., 4545 Augusta Blvd., Chicago, Ill.—RADIO TODAY.



Farnsworth's Caryette model CT-59 has 5 tubes and may be operated 3 ways. Combination on-off switch and safety slide door catch. Moulded plastic and leatherette housing.



**RCA radio-victrola**

★ V-101, 5 tube RCA table model. Plays 10 and 12 in. records with lid closed. Birch veneer with heart walnut and maple veneers. Molded tone arm, crystal pickup. 6 in. loudspeaker. Built-in loop antenna. Superhet circuit magnetite core IF transformer. RCA Mfg. Co., Camden, N. J.—RADIO TODAY.

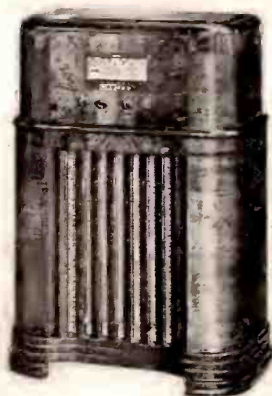

**Howard console**

★ Model 718-C is a 12-tube three-band set tuning from 540 kc to 22 mc. A tuned RF on BC band, and two IF stages are used. Separate bass and treble tone controls permit exact range desired. 12 inch speaker delivers 10 watts. Walnut cabinet; list \$79.95. Howard Radio Co., 1731 Belmont Ave., Chicago, Ill.—RADIO TODAY.



**Sonora phono-radio**

★ Table model phono-radio has 5-tube set tuning standard BC band. Model KNF-148 has built-in loop, PM dynamic speaker. The phonograph has rim-drive motor, crystal pick-up, plays both 10 and 12 inch records with lid closed. Matched veneer walnut cabinet. Sonora Radio and Telev. Corp., 2626 W. Washington Blvd., Chicago, Ill.—RADIO TODAY.



**Zenith 5D610**

★ Table model with five tubes has Wavemagnet, operates from either AC or DC lines. Tunes BC band. 4 inch speaker, brown plastic cabinet, black dial with white numerals. Price, \$11.95. Zenith Radio Corp., 6001 W. Dickens Ave., Chicago, Ill.—RADIO TODAY.

# WESTERN UNION

Send the following message, subject to the terms on back hereof, which are hereby agreed to

ELECTRIC APPLIANCE RETAILERS, U. S. A.

WITH CARLOAD ORDERS FROM RETAILERS MORE  
THAN DOUBLE THOSE OF A YEAR AGO . . .

THE SECOND STEP IN KELVINATOR'S LONG-RANGE  
PROGRAM IS ALREADY A PROVED SUCCESS . . .



What Kelvinator's  
long-range Program of  
Planned Distribution  
and Manufacturing  
means to the Retailer of  
Refrigerators and Ranges



**T**HE long-range Kelvinator program, which this year enters its second period, according to schedule, could only have been created by a "retail-minded" organization.

That important fact is at one and the same time Kelvinator's most valuable possession and the Kelvinator franchise holders' assurance of continuing and expanding profits.

One by one Kelvinator has faced the problems of refrigerator and range retailers—haphazard

step-up pricing—too many retailers—high prices—complacent engineering and product planning—too many models. And, one by one, Kelvinator has sought solutions.

Fortunately for Kelvinator, this "attitude of mind" is perhaps the one thing in business that cannot be copied.

It helps explain the fact that Kelvinator for 1941 is, any way you look at it—"the hot line—and the hot franchise".

Kelvinator Division, NASH-KELVINATOR CORPORATION, Detroit, Michigan



**Get  
More**

**Get**

**KELVINATOR**

## DEFENSE JOBS SPEED RADIO SALES

(Continued from page 15)

worth it. The record department has already been expanded.

At Douglas Radio & Television Co., there's a very aggressive attitude. The report is that "business has picked up steadily" and "people seem to have more jobs." Manager G. W. Douglas likes to use other business people to get additional leads and prospects for radios. He keeps the store open till 9 p.m., has connected with a number of people who work in places where they contact the public. These places often close up earlier, and the "scouts" for Douglas are encouraged to bring their prospects and leads to the radio store before 9 p.m.

### SOUND PROMOTION

These "part-time salesmen" get a fee for their pains, and they help the Douglas volume. This radio man also believes that more "demonstrator" radios should be scattered around in business houses who do not handle radios. He now has receivers spotted in five barber shops, with an accompanying card to mention his store. The barbers are willing because customers like radio music, and Mr. Douglas knows of eight sets that have been sold as a result of the plan. He plans to double the number of radios thus selling themselves. He also has what seems to be a star idea for a program on the local station, plugging radio-recorders especially.

The beforementioned Mr. Cannon of the Troup Music House strikes a note of caution, when asked how to locate and sell the people who are going back to work. He believes that many of these people will need time to "catch up" on financial obligations.

## NEW-BUSINESS BULLETINS

from other cities

**WICHITA, KAN.**—Radio salesmen working outside the Geo. Innes Co. store are using Chamber of Commerce reports in contacting newcomers to this city. Local payrolls expected to be increased by 10,000.

**ALLIANCE, OHIO**—Stronger tone in radio buying reported by Mahan Music Store here. Increase amounts to about 10% with direct calls and newspaper ads being used to contact prospects with new jobs or pay rises.

**COATESVILLE, PA.**—All old accounts at Chertok's store are encouraged to open new ones and to furnish radio leads among new employes hired locally. Reported increase among steel workers here is 1,500.

**BIRMINGHAM, ALA.**—Estimate of increased business at Broadhead Furniture Co. is around 10%. Report is that "people are buying new cars and paying off old debts."

**RIVERSIDE, CALIF.**—Frank A. Nelson, jobber, comments on the effect of defense spending on radio servicing, and reports that his business for January this year was almost double that for 1940.

He prefers just to keep his name and his values in the public eye, via the usual forms of advertising, for the present. He believes in calling on old customers to see that they're satisfied and to get new leads. Troup also gets leads from "key" people in the community who get a commission when sales are made. Otherwise, he depends upon vigorous newspaper advertising and leads from servicemen. Four salesmen are busy, and in the basement are service-shop headquarters for four servicemen.

Other ideas were forthcoming from E. R. McCauley at Darmstaetter's, Carl G. Wetzell of the George Barbey

Co., (jobber), Mr. Kessler of American Auto Stores Co., and Paul Marvel of Paul's Speedometer Service. It was pointed out that if a radio man has an old customer or a personal friend at the factories which are taking on extra workers, these acquaintances should be encouraged to provide radio sales leads. It was also suggested that news programs should be talked up, because after all, the war is causing new activity in Lancaster, and that's just what the broadcast news is about.

### WHICH RADIOS SELL

As for the "wanted" merchandise mentioned by dealers for the healthy business of 1941, the vote of the Lancaster radio men goes to combinations and to recorders. Typical comment among the combination enthusiasts was that "people nowadays want all the extra services that a radio instrument has to offer" and "sometimes they have a single favorite piece of music which they think they want to play over and over again—this will lean them toward a combo."

The importance of radio-recorders was disputed in a few quarters, but the majority reported that these instruments seemed to be good sales bets in the community. "These jobs have helped to identify our store as having the 'newest' in radio and they have given us a chance to hold the kind of demonstration that many people never heard of before."

It is true that the folks in Lancaster are quiet and conservative, and one retailer reports, "they do not go for the fancy gadgets and the tricky new jobs." But other retailers said that the conservative folks are just the ones who want to keep the younger members of the family at home and properly entertained. And recorders are ideal for this job.

## Brilliant, Clear, Large-Screen Telepictures Make Bid for FCC "Go Ahead"

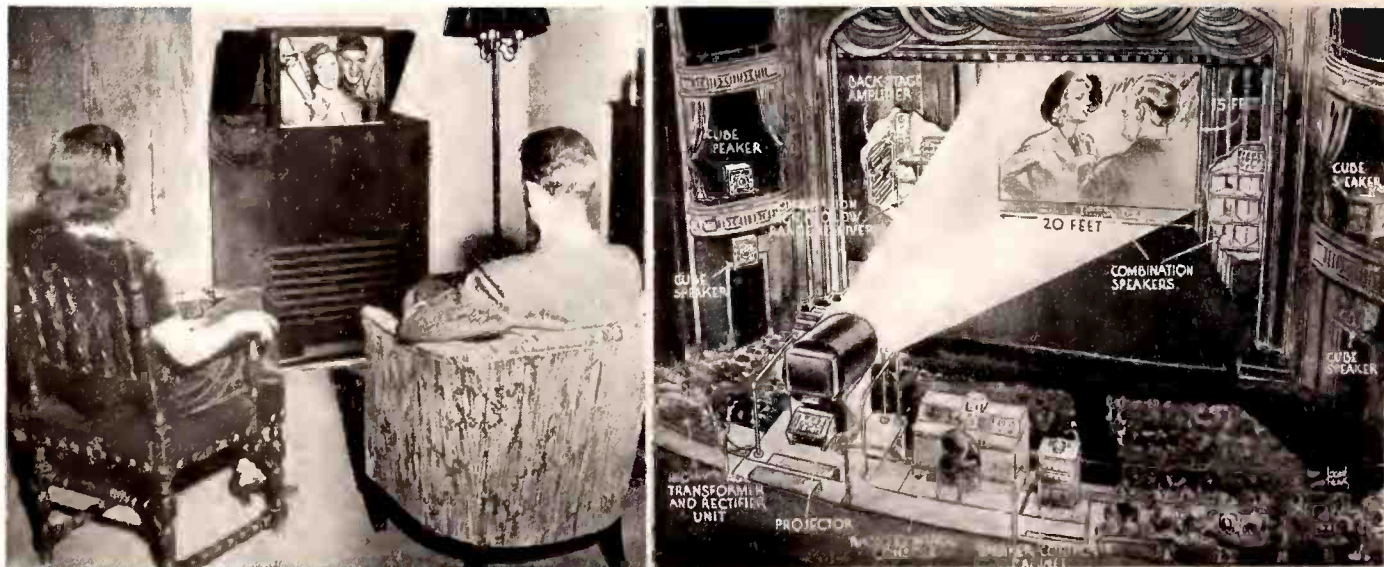

Television progress shown by RCA for FCC and National Television System Committee. Left, latest home unit with projected picture on screen 13½ by 18-in. Right, full-size theater projection on screen 15 by 20 ft., showing elaborate apparatus. FCC holds new "commercialization" hearing Mar. 20.

# Announcing

a New Development by  
One of America's Best  
Known Manufacturers in  
the Radio Parts Industry

## EXCLUSIVE PUSH-PULL FEATURE

Turner Vibrators do not depend on the springing action of steel, but employ an equal amount of magnetic power to PULL, then PUSH the reed and its contacts. A harder-faster swing of the reed gives you a cleaner, more positive contact. The rolling, wiping action of the contact means a large, clean contact every time. Piling and chattering are eliminated and R. F. hash reduced. Mechanical noise takes a real licking, too.



## CONTACT POINTS MICRO ADJUSTED AT FACTORY

Adjustable screws, held in place with lock nuts, permit micro adjustment of contact points at the factory. You're sure of a precision adjustment with sure-fire operation. Customer complaints and extra servicing eliminated.

## STACK TYPE ASSEMBLY ELIMINATED

The old-fashioned stack type assembly is done away with in Turner Vibrators. Instead, you get 100% closed dual magnetic path, with increased efficiency. You're safe from short circuits caused by deterioration or slipping insulation, common to old type stack assemblies.

## IT COSTS NO MORE

See for yourself the 10 definite engineering advancements in a Turner Vibrator. You get ALL THESE at NO ADDITIONAL COST. The Turner Vibrator MANUAL is FREE. Ask Your Jobber TODAY, or write The Turner Co., Cedar Rapids, Iowa.

TIME TO TURN TO



BE SURE TO ASK FOR TURNER  
VIBRATOR MANUAL TV

Not just another Vibrator — but a Vibrator with 10 engineering advancements that FREE YOU from customers' irksome complaints and keep users happy with your service. Turner Vibrators give you more stable operation, longer life and fewer servicing headaches. You'll like the exclusive Push-Pull feature — the self-cleaning contacts — the micro adjustment of the contact points at the factory — the elimination of the old type stack assembly — the low drain and the high output. Each unit is packed in factory-sealed cartons — your assurance of new merchandise. Cartons have open terminals for testing the Vibrators. Guaranteed for One Year by the same manufacturer who makes the famous Turner Microphones. Available in models to meet all replacement calls. See for yourself what a Turner Push-Pull Vibrator will do! Ask your Jobber Today, or write The Turner Co., Cedar Rapids, Iowa.

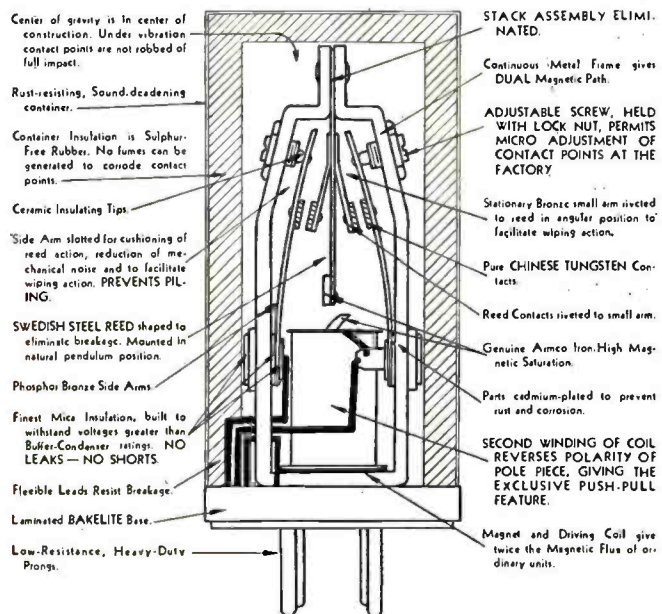

# REFRIGERATORS MOVE

Most of the dealers of the nation have recently attended the snappy showings of the 1941 lines of refrigerators. They have been exposed to more sales-getting promotions, more really important improvements, and more opportunities for new profits, than they can recall for the total of the last few seasons.

Exceptional features of the new lines have been noted on the first 10 makes of boxes to be introduced this year. These include Crosley, Gale, General Electric, Gibson, Hotpoint, Kelvinator, and Leonard, Norge, Philco, Stewart Warner and Westinghouse. The sales news on these makes have been reported in the November, December and January issues of **RADIO TODAY**. The latest string of boxes to be shown, those of Frigidaire, are represented herewith.

## DEALERS SIGNAL

Just as the last of the sleek new models went on the market, it was revealed by the National Electrical Manufacturers Association that domestic sales of household refrigerators to dealers and distributors during 1940 had added up to 2,528,566 units, as compared with 1,819,641 the previous year, an increase of nearly 39 per cent. NEMA gets reports from 13 refrigerator companies. It is expected that the strong upswing in buying power, as a result of the National Defense Program, will boost this increase even more sharply for the year at hand.

Thus it can be seen that dealers have significant merchandise for the season and a brand new surge of buying power coming to meet it. But the prospects for profit are even further improved by a number of big-scale promotions being announced by the manufacturers, so that the man who has the new boxes for sale can get promptly connected with the buyers.

For instance, Hotpoint has just introduced the "Hostess Club" idea designed to help the retailer get full benefit from their customers' enthusiasm for Hotpoint appliances. A year-round program, it provides gifts for Mrs. Homemaker if she will help the dealer sell more products. It applies to all Hotpoint appliances, including the new line of 15 refrigerators. This company had already made news with new features for 1941.

## BANNER SEASON

Philco reports that dealer orders indicate "another banner year for the refrigeration industry" and that the company is ready with its most spectacular sales-making promotions. This firm has chalked up a 300 per cent increase in its box sales and now with its "new kind of refrigerator" is emphasizing year-round profits for the dealer with a sweeping advertising and promotion drive behind the complete line of 9 units.

Frigidaire is busy getting its striking new cabinet styles across to the public, and dramatically telling the story of improved Cold-Wall features. This line has been cut from 24 models



The Commodore "8" by Gale Products is brand new for larger homes. Complete luxury features, twin freezers.

in 1940 to 15 for 1941, and has been developed after months of surveying refrigerator users and dealers to determine the new standards for a modern electric refrigerator. Frigidaire recently announced that all owners of 1936 boxes with sealed-in rotary type cold making units will be offered an extended protection plan of the unit.

Kelvinator has announced a "blast" for its 8 new models in newspapers, magazines and spot radio. The new Moist-Masters are being promoted to the public on an oversized scale and this year accents "step-up buying" as a new profit plan for the dealer.

General Electric is helping sales with the "All-Star" promotions on 1941 boxes. Total units in the line is 16 but GE has group of "sevens" designed especially for the replacement market. The "Stars" in the GE drive stand for 10 separate storage and preservation services offered in the new designs.

Westinghouse is making a special appeal to women by using models designed in the colonial mode and named for famous American women. Also the new interior colors of these units will get a big play. Advertising on Westinghouse appliances will be increased from 10 to 15 per cent this year. New "informative" tags also help dealers.

Norge has a couple of catch phrases for its new units this year, which lend themselves well to eye-catching promotion. The firm plays up the "Night Watch" feature and speaks of "Hollywood Beauty Styling" for an important sales drive on the 12 models in the line.

Consumer demand for the new Crosley jobs is being whetted by "the great-

## NEW ROOM-COOLER SEASON CLAIMS DEALER ATTENTION

"I think I'll put them up front this year," said one radio man, when asked about room coolers for the approaching season. He's already planning a display spot for these units, and many other dealers and jobbers are, too.

The last year wound up with total U. S. sales of around 20,000 room coolers, which was 30 per cent better than the previous annual figure. These jobs are catching on, but certainly there's a big untouched market left, when you consider how the 1940 yearly volume compares with 2,538,566 refrigerators sold, and the 11,600,000 radios that went out during the same period.

The peak months for retail selling of room coolers are June and July, but these products start to sell in some areas as the days of March and April begin to suggest the warmth of summer. Thus it happens that radio men are looking at what new models the manufacturers have to offer, and to make definite, aggressive plans for the vigorous promotion of the new coolers.

Manufacturers are already making announcements on improved units and new prices, and some are under way with campaigns to get the prospects interested. Throughout this activity, the alert retailers are remembering that this year, as one expert puts it, a buying streak is due. The expendi-

tures of the Defense Program are helping the general buying power of the public, and a three billion dollar residential building program is planned for 1941. Not to mention the fact that the number of marriages is on the increase.



Philco has big-scale promotion plans for its new room ventilator, to sell at \$39.50. It's a 26 lb. double-duty walnut unit, easily installed.



GE has introduced this accessory cabinet, to fit any "6" of the last 5 years. Provides 6 cu. ft. extra space.

est national advertising in the firm's history." For retailing convenience, the line has been cut to only five models, which will be widely exploited with emphasis the "Food to the Front" via the new super Shelvador.

Sales of Crosley refrigerators in January of this year were 107 per cent over the same month last year (radios are up 86 per cent). The last few weeks have seen repeated step-ups in production, to meet consumer demand.

At Stewart Warner, the accent goes to the Dual-Temp features on the group of eight new models described as "The Refrigerator of Tomorrow." The SW officials believe that they have alertly filled all the demands of a replacement market with the 1941 design and dealer profit policy.

The spearhead of the Gale merchandising plan this year is concerned with "extras" for the public. The 7 models in the line are complete with features planned so that all types of buyers can be handled with a good profit for the dealer.

The new Gibson line of 9 Freez'r Shelf models is being publicized via newspaper advertising, outdoor poster ads, and an extra number of sales helps for dealers. Gibson invites the consumer to "check all three," meaning cabinet, mechanism and conveniences.

### Trend to Higher Unit Prices

"The average unit price of refrigerators sold in 1941 should be at least 10 per cent above the average for 1940," W. Paul Jones, Philco refrigerator head, has reported. The prediction follows a nationwide survey.

"While the average unit price last year was \$145, advance orders and market conditions indicate that this figure will be raised to about \$160," Mr. Jones declared. This would represent a total dollar volume for the industry of approximately \$475,000,000 if the forecast of a 3,000,000 unit sale for 1941 holds good.

"Our anticipation of a considerable increase in dollar volume per unit is

further substantiated by the fact that the Philco MAH-7, the leader in our Advance Design group, retailing at more than \$200, has been the sensation of the line," the Philco executive explained.

One factor which stimulated dealer reaction at the 30 Philco sectional meetings was the display possibilities of the Advance Design line, analysis showed. The popularity of the MAH-7, it was said, was based on its value as an eye-catcher, and the fact that it, along with other top models, has a giant frozen food compartment and the improved conservador.

### Crosley Shows New Lines to Store Managers

Head men of The Crosley Corp., Cincinnati, introduced the 1941 lines of Crosley refrigerators, radios, ranges and washers to more than 100 store managers at a dinner-meeting for members of the Retail Service Stores group at Chicago Towers, Chicago, last month.

Executives on the program included Robert I. Petrie, vice-president and sales manager, and L. Martin Krautter, manager of advertising and sales promotion.

Mr. Petrie outlined the company's sales program for 1941, and said that the sales volume already is more than 35 per cent above quotas set at the company's recent mid-winter national convention in Cincinnati.

Mr. Krautter explained the company's 1941 advertising and sales promotion program, emphasizing the timely appeal of the theme, "Twice as much food to the front."



Here's the new exterior design by Frigidaire for 1941 Cold Wall models. This is a Deluxe 6, tagged at \$204.75.

### Dealer Moves Into Finer Quarters

A new and up-to-the-second radio and electrical store is being opened at 872 E. Tremont Ave., Bronx, N. Y., by the Ritz Radio & Appliance Co., Inc. The Ritz firm, headed by J. M. Messinger, has been doing business for 20 years at 1024 E. 180th St., Bronx, but will move this week to the more modern quarters.



### CAP SAYS:—

H. L. M. CAPRON  
Merchandising  
Editor

### Read the Handwriting on the Wall!

Twenty years ago, when radio appeared on the scene, phonograph dealers looked upon the radio infant as an upstart. All the dealers except a few smart ones.

We now know that because the rank and file of the phonograph dealers did not take radio to their hearts, a whole new group of merchants *did* take it on. They were more alert to their opportunities. And the old-time phono dealer mostly faded from the picture.

Today, phonograph records, personal radios, FM and new short-wave developments present a similar picture to the radio dealer. Radio men who shun records, look down on the personal compacts, and talk against new developments, are sending people to the more alert merchants, and thereby creating a whole new group of competitors.

The public will not be denied what it wants, and it does want records, personal compacts, combinations, FM and eventually television.

*Read the handwriting on the wall!*

# New 1941 Advanced Design **PHILCO** **REFRIGERATOR**

*the Sensation of the Industry!*

## **OUTSTANDING ATTRACTION AT FURNITURE MART!**

The display of new Philco Refrigerators at the Furniture Mart in Chicago is the high-spot of the show! The eye-catching beauty and easily demonstrated advantages of the new Philco make it a sensational standout wherever it is exhibited!

## **CONVENTION ORDERS DOUBLE LAST YEAR'S!**

Yes, at the recent National Convention in Chicago, orders for the new 1941 Philco Refrigerator *more than doubled those of last year's convention!* This amazing new Philco, with its new beauty, new, exclusive services, new dependability and economy will sell itself on sight to your customers, too!

## **MOST SALEABLE FEATURES EVER OFFERED!**

*Only Philco offers you the Conservador . . . plus separate compartments for Dry Cold, Moist Cold and Frozen Foods . . . the amazing new Philco Super Power System that features SUPER-FINISH . . . the numerous other services that bring new modern benefits to the housewife . . . all saleable features she can instantly see and appreciate!*

## **SMASH HIT AT DEALER MEETINGS!**

During the past few weeks dealers all over the country have met and marvelled at this new creation of Philco engineering genius. The amazing number of orders placed by dealers at these meetings is real proof of their enthusiasm over the 1941 Advanced Design Philco Refrigerator! It's a Refrigerator that will *make more money for you* because its exclusive, visible sales features give you a better chance to use your talents as a salesman!

## **See Your Philco Distributor**

Don't wait! See your Philco Distributor or call him now. Get set up for the biggest refrigerator year you've ever had . . . with PHILCO!

**PHILCO ALL YEAR 'ROUND . . . the**





THE GREATEST  
REFRIGERATOR  
EVER BUILT . . .  
**PHILCO**  
Advanced Design  
MODEL MAH-7

Most Valuable Franchise in the Appliance Field!

New 1941 Advanced Design

# PHILCO REFRIGERATOR

*--the Sensation of the Industry!*

## OUTSTANDING ATTRACTION AT FURNITURE MART!

The display of new Philco Refrigerators at the Furniture Mart in Chicago is the high-spot of the show! The eye-catching beauty and easily demonstrated advantages of the new Philco make it a sensational standour wherever it is exhibited!

## MOST SALEABLE FEATURES EVER OFFERED!

Only Philco offers you the Conservador... plus separate compartments for Dry Cold, Moist Cold and Frozen Foods... the amazing new Philco Super Power System that features SUPER-FINISH... the numerous other services that bring new modern benefits to the Housewife... all saleable features she can instantly see and appreciate!

## CONVENTION ORDERS DOUBLE LAST YEAR'S!

Yes, at the recent National Convention in Chicago, orders for the new 1941 Philco Refrigerator more than doubled those of last year's convention! This amazing new Philco, with its new beauty, new, exclusive services, new dependability and economy will sell itself on sight to your customers, too!

## SMASH HIT AT DEALER MEETINGS!

During the past few weeks dealers all over the country have met and marvelled at this new creation of Philco engineering genius. The amazing number of orders placed by dealers at these meetings is real proof of their enthusiasm over the 1941 Advanced Design Philco Refrigerator! It's a Refrigerator that will make more money for you because its exclusive, visible sales features give you a better chance to use your talents as a salesman!

## See Your Philco Distributor

Don't wait! See your Philco Distributor or call him now. Get set up for the biggest refrigerator year you've ever had... with PHILCO!



**PHILCO ALL YEAR 'ROUND . . . the Most Valuable Franchise in the Appliance Field!**

# SELLING SOUND ALL AROUND

**Finding jobs to install in your neighborhood. Selling points for industrial, and commercial sound installations.**

All sound jobs are not associated with huge auditoriums, stadiums, and other few and far between locations. Many jobs are right around the corner from your place of business.

Many times, the jobs won't know they are there, but some selling will show it to be the case. For example, there are probably three or four "gas" stations within a few blocks of your store. One or maybe two of them have washing or greasing racks in separate buildings, or at least in separate rooms. Here is a real prospect for two-way inter-communication. The extra convenience and greater speed in handling jobs will sell the system.



Sound systems are needed in busy industrial plants.

## AUTOMOBILE JOBS

Along in the automotive field are the garages, parking lots, taxi and bus centers which need calling, announcing, and inter-comm. systems.

Parking-lot operators in particular have the problem of bringing cars in from the lot when they are called for by the owner at the lot office. Running back and forth between the far end of the field and the office is unnecessary when a two-way call system would allow an assistant to pick up the car whose license number is relayed to him from the office.

A typical parking lot system would consist of a 3 to 5-watt amplifier, mike with talk-listen switch, PM speaker for office, a PM speaker and weather-proof trumpet for the far-end of the lot. Wiring of course should be a very good grade of weather proof cable. Keep it away from telephone, and power lines to avoid inductive

pick-up. The talk-listen switch can be a double pole double throw to switch the remote speaker from the amplifier output to the input transformer.

Traffic direction and control is another good field for the sound man. Bridges, cross roads, viaducts, and busy intersections within the town need mobile or fixed PA units to speed the flow of cars, and avoid accidents.

Mobile units such as the one shown in the Texas traffic control truck are typical of the types needed. These trucks are equipped and usually maintained by the sound man. There are excellent profit opportunities in the initial sale of the equipment and the continued servicing of the units.

The truck shown was equipped by Olsen Radio Supply Co. of San Antonio. An Erwood 20-watt amplifier with built-in phono turntable is used to drive the Atlas speakers on the roof. It is used to patrol the streets and guard busy intersections against traffic violations.

Bridges, toll roads, highway crossover and intersections also need amplifiers and speakers for routing traffic.

The San Francisco-Oakland bridge uses a PA system to keep the passenger and commercial traffic properly separated and flowing over this largest of all spans.

Atlas Sound Corp, exponential projectors and PM drivers are mounted over the toll booths at the Oakland end of the bridge. These speakers are controlled by a police sergeant at a

master traffic control station. Instructions given the motorists guide them in entering the correct lanes.

Further back from the bridge, on the approaches, another speaker directs the first division of the passenger and truck traffic.

Bridges, and other highway sections which may have use for this type of sound control, are usually under the control of county or city high-way departments. The best time to sell this type of job is during the construction stage. Traffic control engineers are the ones to see about their plants for sound equipment. By working with them on the design and layout, the jobs can be sold.

This type of outdoor sound system requires plenty of power, and equipment that will stand up under long periods of use.

## INDUSTRIAL SOUND

Factories are excellent markets for complete sound systems. Added defense business has doubled and tripled man-power in many plants throughout the country. This extra personnel must be used efficiently, and sound fills a big order in helping with this job.

A few of the things that sound can do in small plants and factories near you are as follows.

1. Speed office work and executive direction with complete, efficient two-way inter-communication among the firm heads.

All of your local orchestras are excellent prospects for compact sound systems to be used as individual instrument amplifiers. Sell mikes, amplifiers, complete units.



# ND YOU

2. Speed up production by using sound communication systems to place orders in the various departments, route material through the manufacturing processes, get tools and special equipment into the correct departments, direct loading and crating of special and rush orders.

3. Save valuable man-hours by overriding high machine noise levels with instructions, etc.

4. Sound systems can speed up the processes of delivery of raw materials, and shipping of the finished products by directing trucking in the un-loading and loading area.

5. Monotony of routine piece work may be alleviated by use of amplified music delivered in the working area by a PA system.

6. Employee recreation rooms need to be equipped with a PA system. Game rooms, athletic fields are definitely in the sound man's class.

The factory picture shows a weather-proof speaker being used for giving yard instructions.

## LOCAL ORCHESTRA JOBS

Every town has several aspiring bands who can use lots of PA equipment in the modern trend toward amplified instruments. Many popular small orchestras use several amplifiers to boost the volume of the usually weak instruments, violins, and other stringed instruments. The band market needs amplifiers, mikes, speakers, contact mikes, special foot volume controls, tubes, etc.

Get the names of the leaders of these bands from the local sheet music store, newspaper, country-club officials

Traffic control and safety campaign trucks are being used by many city police departments. Sound men can equip and maintain the system. Olsen Radio Co., San Antonio, Texas did job below.



FEBRUARY, 1941

or other social organization. Talk to these leaders, and let them try out individual pick-up with foot type volume controlled amplifier on several of the instruments in the band.

Sound systems for orchestras need to be the example of compactness, ruggedness, and dependability. Lay out any system you plan to sell to orchestras for the least number of controls, interconnections, and weight. A job that will be self-contained is also easier to sell. Be sure that the mike, speaker, cables, and amplifier can all be quickly placed into a single convenient case.

## RENTAL BUSINESS

It is advisable to have some of the right types of sound systems for orchestras available for renting. In this way, a band can try out the new effects of amplified instruments and sell themselves the sound system.

An accompanying photo shows the popular Russ Morgan band which features "Singing Strings."

Stringed instruments were not formerly featured in dance orchestras because of the low volume of the sound they produced. However, with the use of contact mikes and amplifiers, they are now able to compete with the brass instruments. The more flexible violins can produce many musical effects, which when amplified, become the main feature of the orchestra.

The violinists shown in the Morgan band picture have Amperite Co. Kontakt pick-up units clamped under the bridges of their instruments.

## OTHER JOBS NEAR

A good many other jobs are near you and take only a little investigating to hunt them out.

Suppose that the department store up the street is holding an anniversary sale, or any other sale. Go to the store manager and suggest using a sound system in the store to announce the various special bargains of the day and the floor on which the merchandise will be found. A rather simple

## YOUR NEARBY SOUND MARKETS

- Automobile service stations
- Parking lots
- Garages
- Bus depots, taxi offices
- Bridges, ferry entrances
- Police traffic department
- Factories
- Offices
- Stores
- Local orchestras
- Dramatic and business clubs.
- Schools
- Churches
- Athletic fields
- Skating rinks
- Dance halls
- Restaurants
- Hotels



Bridges, traffic intersections, ferry entrances, use sound like this San Francisco bridge approach.

system with box-type wall mounted speakers could be quickly installed and rented for the period of the sale.

A local manufacturing plant is having a convention, for their representatives, etc. An inspection trip through the plant will certainly be a feature of the program. Here the sound man can rent an amplifier system to help the guide explain operations of machines and processes where the noise level makes ordinary conversation impossible.

## SELLING THE JOB

The banquet and business sessions will also need a PA system for the speakers, entertainment, etc.

Many similar everyday events offer real opportunities to the active sound man. By keeping up with these events and getting there first with the right system, will keep your sound business "humping."

31

# SELLING SOUND ALL AROUND YOU

**Finding jobs to install in your neighborhood. Selling points for industrial, and commercial sound installations.**

All sound jobs are not associated with huge auditoriums, stadiums, and other few and far between locations. Many jobs are right around the corner from your place of business.

Many times, the jobs won't know they are there, but some selling will show it to be the case. For example, there are probably three or four "gas" stations within a few blocks of your store. One or maybe two of them have washing or greasing racks in separate buildings, or at least in separate rooms. Here is a real prospect for two-way inter-communication. The extra convenience and greater speed in handling jobs will sell the system.



Sound systems are needed in busy industrial plants.

## **AUTOMOBILE JOBS**

Along in the automotive field are the garages, parking lots, taxi and bus centers which need calling, announcing, and inter-comm. systems.

Parking-lot operators in particular have the problem of bringing cars in from the lot when they are called for by the owner at the lot office. Running back and forth between the far end of the field and the office is unnecessary when a two-way call system would allow an assistant to pick up the car whose license number is relayed to him from the office.

A typical parking lot system would consist of a 5 to 6-watt amplifier, mike with talk-listen switch, PM speaker for office, a PM speaker and weather-proof trumpet to the far-end of the lot. Wiring of course should be a very good grade of weather proof cable. Keep it away from telephone, and power lines to avoid inductive

pick-up. The talk-listen switch can be a double pole double throw to switch the remote speaker from the amplifier output to the input transformer.

Traffic direction and control is another good field for the sound man. Bridges, cross roads, viaducts, and busy intersections within the town need mobile or fixed PA units to speed the flow of cars, and avoid accidents.

Mobile units such as the one shown in the Texas traffic control truck are typical of the types needed. These trucks are equipped and usually maintained by the sound man. There are excellent profit opportunities in the initial sale of the equipment and the continued servicing of the units.

The truck shown was equipped by Olsen Radio Supply Co. of San Antonio. An Erwood 20-watt amplifier with built-in phono turntable is used to drive the Atlas speakers on the roof. It is used to patrol the streets and guard busy intersections against traffic violations.

Bridges, toll roads, highway cross-over and intersections also need amplifiers and speakers for routing traffic.

The San Francisco-Oakland bridge uses a PA system to keep the passenger and commercial traffic properly separated and flowing over this largest of all spans.

Atlas Sound Corp. exponential projectors and PM drivers are mounted over the toll booths at the Oakland end of the bridge. These speakers are controlled by a police sergeant at a

master traffic control station. Instructions given the motorists guide them in entering the correct lanes.

Further back from the bridge, on the approaches, another speaker directs the first division of the passenger and truck traffic.

Bridges, and other highway sections which may have use for this type of sound control, are usually under the control of county or city highway departments. The best time to sell this type of job is during the construction stage.

Traffic control engineers are the ones to see about their plants for sound equipment. By working with them on the design and layout, the jobs can be sold.

This type of outdoor sound system requires plenty of power, and equipment that will stand up under long periods of use.

## **INDUSTRIAL SOUND**

Factories are excellent markets for complete sound systems. Added defense business has doubled and tripled manpower in many plants throughout the country. This extra personnel must be used efficiently, and sound fills a big order in helping with this job.

A few of the things that sound can do in small plants and factories near you are as follows.

1. Speed office work and executive direction with complete, efficient two-way inter-communication among the firm heads.

or other social organization. Talk to these leaders, and let them try out individual pick-up with foot type volume controlled amplifier on several of the instruments in the band.

Sound systems for orchestras need to be the example of compactness, ruggedness, and dependability. Lay out any system you plan to sell to orchestras for the least number of controls, interconnections, and weight. A job that will be self-contained is also easier to sell. Be sure that the mike, speaker, cables, and amplifier can all be quickly placed into a single convenient case.

## **RENTAL BUSINESS**

It is advisable to have some of the right types of sound systems for orchestras available for renting. In this way, a band can try out the new effects of amplified instruments and sell themselves the sound system.

An accompanying photo shows the popular Russ Morgan band which features "Singing Strings."

Stringed instruments were not formerly featured in dance orchestras because of the low volume of the sound they produced. However, with the use of contact mikes and amplifiers, they are now able to compete with the brass instruments. The more flexible violins can produce many musical effects, which when amplified, become the main feature of the orchestra.

The violinists shown in the Moran band picture have Amperite Co. Kontakt pick-up units clamped under the bridges of their instruments.

## **LOCAL ORCHESTRA JOBS**

Every town has several aspiring bands who can use lots of PA equipment in the modern trend toward amplified instruments. Many popular small orchestras use several amplifiers to boost the volume of the usually weak instruments, violins, and other stringed instruments. The band market needs amplifiers, mikes, speakers, contact mikes, special foot volume controls, tubes, etc.

Get the names of the leaders of these bands from the local sheet music store, newspaper, country-club officials

Traffic control and safety campaign trucks are being used by many city police departments. Sound men can equip and maintain the system. Olsen Radio Co., San Antonio, Texas did job below.

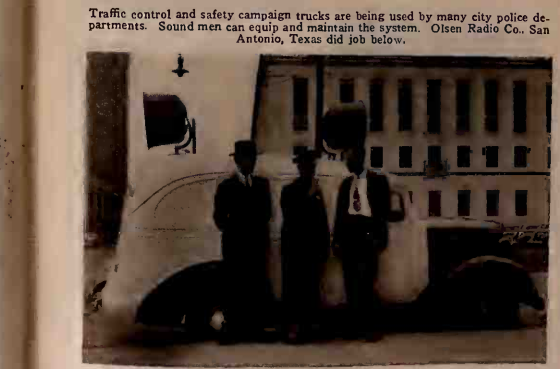

FEBRUARY, 1941

## **YOUR NEARBY SOUND MARKETS**

- Automobile service stations
- Parking lots
- Garages
- Bus depots, taxi offices
- Bridges, ferry entrances
- Police traffic department
- Factories
- Offices
- Stores
- Local orchestras
- Dramatic and business clubs.
- Schools
- Churches
- Athletic fields
- Skating rinks
- Dance halls
- Restaurants
- Hotels



Bridges, traffic intersections, ferry entrances, use sound like this San Francisco bridge approach.

system with hook-type wall mounted speakers could be quickly installed and rented for the period of the sale.

A local manufacturing plant is having a convention for their representatives, etc. An inspection trip through the plant will certainly be a feature of the program. Here the sound man can rent an amplifier system to help the guide explain operations of machines and processes where the noise level makes ordinary conversation impossible.

## **SELLING THE JOB**

The banquet and business sessions will also need a PA system for the speakers, entertainment, etc. Many similar everyday events offer real opportunities to the active sound man. By keeping up with these events and getting there first with the right system, will keep your sound business "bumping."

# MORE NEW PRODUCTS

Merchandise in timely release from manufacturers aiming at the extra consumer demand this Spring



## Farnsworth portable

★ Model CT-60 portable has tapered design and is finished to resemble expensive luggage. The six tube set features a tuned RF stage, oversized PM speaker. The new luggage type portable has greater sensitivity and freedom from cross-talk. The list price on CT-60 is \$29.95. Farnsworth Telev. and Radio Corp., Ft. Wayne, Ind.—RADIO TODAY.

normal ceiling height) is 14" x 26 $\frac{3}{4}$ " x 15". Providing filtering and ventilating with or without mechanical cooling. Removes approximately 1 qt. of water per hour when cooling air.  $\frac{1}{2}$ -HP motor. No plumbing required. Philco Radio & Telev. Corp., Phila., Pa.—RADIO TODAY.

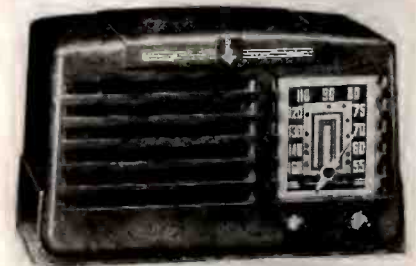

## Emerson "Big Six"

★ A 6-tube superheterodyne in ivory (\$12.95) or walnut (\$14.95) bakelite, model 414 has extra RF stage, super-loop antenna, large dynamic speaker, A.V.C. All American broadcasts and police. 7 $\frac{1}{4}$  in. high, 12 $\frac{3}{4}$  in. wide, and 6 in. deep. Emerson Radio & Phono Corp., 111 8th Ave. New York, N. Y.—RADIO TODAY.



## Cruzair phono-radio

★ Model 703 table size phono-radio uses seven tube superhet receiver with 3 $\frac{1}{2}$  watts audio power. Built-in loop antenna, 6 inch dynamic speaker, variable tone control. Automatic record changer. Hamilton Radio Corp., 142 W. 26th St., New York, N. Y.—RADIO TODAY.

## Zenith console

★ Model 10S567 is one of 15 new sets just introduced. Has radiorgan tone control; wavemagnet. Tunes BC and shortwave ranges. 10 tubes. The push-pull output tubes drive a 14-inch speaker. The walnut cabinet is 42 inches high. List \$89.95. Zenith Radio Corp., 6001 W. Dickens Ave., Chicago, Ill.—RADIO TODAY.



## Motorola auto set

★ Model 451 is one of eight new sets featuring "Vita-Tone," a development in the electrical and acoustical circuits. This set has 5 push buttons, six tubes, panel or bulk-head speaker. Price, \$44.95. Other models range from \$69.95 8-tube set to dash mounting 6-tube set at \$24.95. Galvin Mfg. Co., 4545 Augusta Blvd., Chicago, Ill.—RADIO TODAY.



## Philco air conditioner

★ Model 61 air conditioner recommended for rooms approximately 15 x 19 (or 285 square feet with



## Admiral table combo.

★ Model 70-K5 automatic record changing combination uses 5 tubes in the radio circuit. The superhet features variable tone control, bass compensation, loop antenna, 6 inch PM speaker. The record changer handles twelve 10 inch or ten 12 inch records and has a Pfanstiehl lifetime needle. Tuning range, 545 to 1630 kc. List, \$49.95. Continental Radio and Tele. Corp., 3800 W. Cortland St., Chicago, Ill.—RADIO TODAY.

## Sonora console grande

★ Model KXF95 is a radio-phonograph with an automatic record changer. has 6 tubes, AC superhet which tunes 2 bands. Built-in Sonora-scope, 6-station push button tuning. Dynamic speaker. Plays eight 10 in. or seven 12 in. records. Walnut veneer cabinet. Sonora Radio & Telev. Corp., 2626 W. Washington St., Chicago, Ill.—RADIO TODAY.

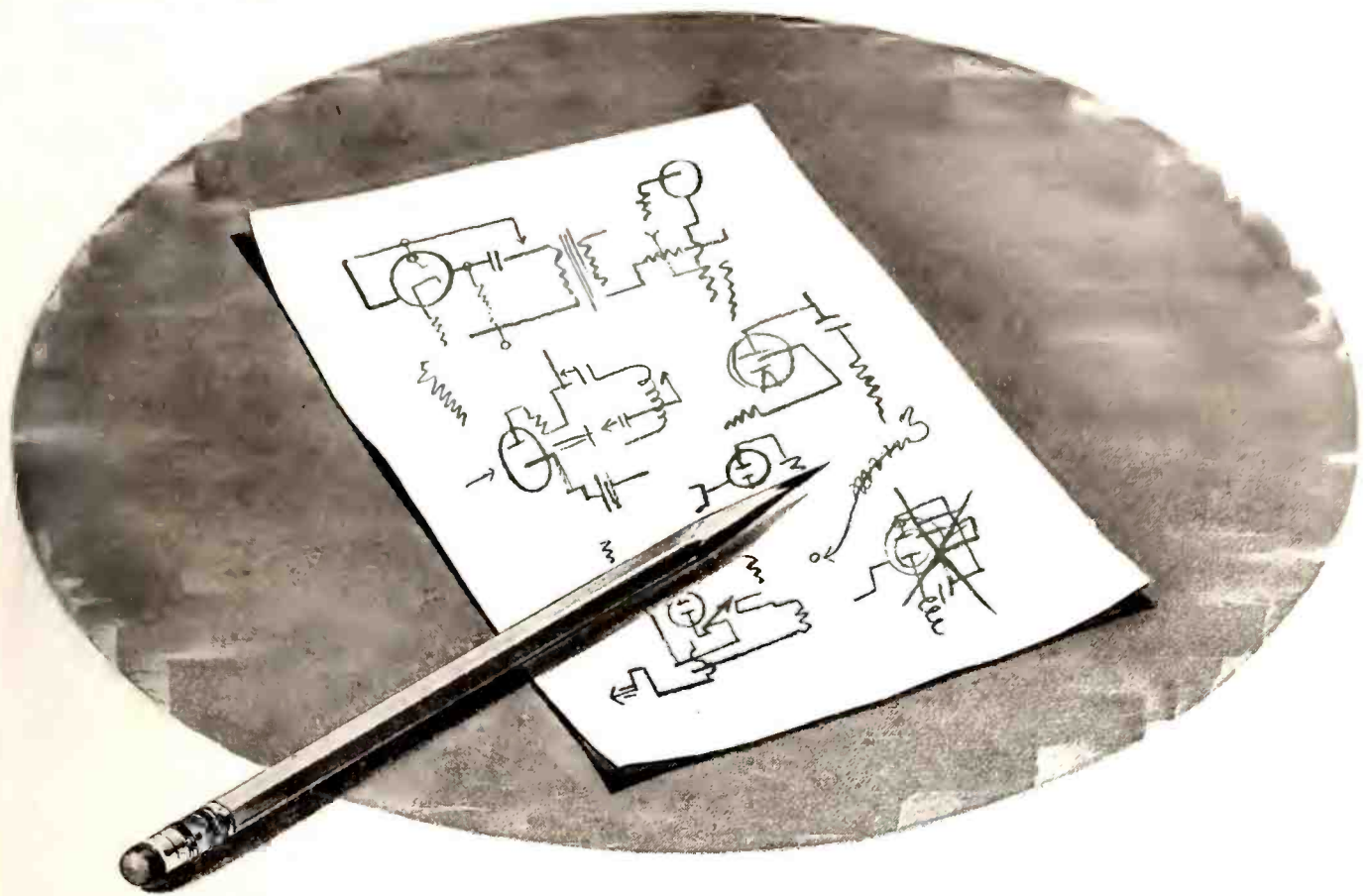

## "DOODLES" THAT MAY AFFECT MILLIONS OF LIVES!

*Here, insignificant on his scratch pad, are the "doodles" of a radio engineer. . . "Doodles" that may well be the foundation of a highly significant development when RCA Research and team work have finished with them*

"Doodling" is a habit of thinkers. And that is why the scratch pads of radio engineers are often a pattern of "doodles." These men are ever thinking, probing, studying in their ceaseless efforts to uncover new radio devices and services.

To this end, RCA Research plays an important part. The scores of outstanding developments that have first seen the light of day in the RCA Laboratories are concrete proof of the progress research makes possible.

In conducting research, RCA engineers and scientists have at their disposal the greatest experience in electronics

and sound. RCA is the only organization that makes and does everything in radio. Broadcasting problems frequently find solution in the experience of the National Broadcasting Company. . . Communications problems are more easily solved with the assistance of R. C. A. Communications, Inc. . . The answers to manufacturing problems may be secured through consultation with men at the RCA Manufacturing Company. . . Problems encountered in marine radio development are overcome with the help of the Radiomarine Corporation of America. In short, the aid of the entire organization is extended to those in the RCA Laboratories who look to the future.

So with "doodles" as a start, followed by intensive research and team work, the magic of radio plays an important role in the lives of millions.



# RADIO CORPORATION OF AMERICA

RADIO CITY, NEW YORK

*The Services of RCA—*

RCA MANUFACTURING COMPANY, INC. • RADIOMARINE CORPORATION OF AMERICA • RCA LABORATORIES  
NATIONAL BROADCASTING COMPANY, INC. • R. C. A. COMMUNICATIONS, INC. • RCA INSTITUTES, INC.

# NEW SOUND PRODUCTS

From the P.A. manufacturers comes new equipment to use on those seasonal jobs now coming up

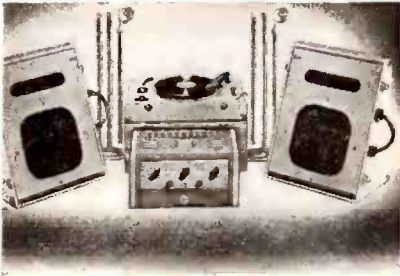

## Erwood sound system ..

★ New 28-watt portable system has case of special design to permit carrying of two full-length floor stands for mikes. Record playing attachment also included in carrying case. Amplifier is model 3428 with provision for two mike and one phono channel. Erwood Sound Equip. Co., 223 W. Erie St., Chicago, Ill.—RADIO TODAY.

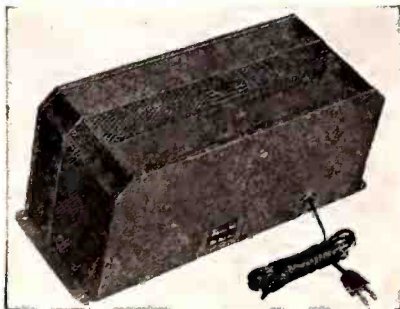

## UTC "Steady-volt"

★ New type of voltage regulator maintains constant output voltage within 1 per cent with input variation from 95 to 130-volts. Output voltage variation is negligible with variation in load. No moving parts. United Transformer Corp., 150 Varick St., New York, N. Y.—RADIO TODAY.

## Aerovox hi-volt tubulars

★ Oil-filled by-pass capacitors for use in amplifiers, transmitters, etc., have cadmium-plated brass shell and varnished paper jacket. Have center mounting strap. Available in 400 v., 600 v., 1000 v., and 2000 v., ratings, .006 to .5 mfd. capacities. Aerovox Corp., New Bedford, Mass.—RADIO TODAY.



## Presto turntable

★ High quality dual speed turntable has 12 inch cast aluminum table dynamically balanced. Rubber tired rim on turntable is driven by metal motor pulley. Slip-over pulley changes speed from 78 to 33 $\frac{1}{3}$  RPM. List price \$50 for 110-volt 60 cycle unit. Presto Recording Corp., 242 W. 55th St., New York.—RADIO TODAY.

## Electro Voice Cardak

★ New poly-directional model dynamic mike adjustable to eliminate rear or side-wall reflection. Substantially flat from 30 to 10,000 cps. Output level is -52 decibels. Chromium finish. Tilt head. High impedance. Complete with 20-foot cable. Model 725. Electro-Voice Mfg. Co., 1239 South Bend Ave., Chicago, Ill.—RADIO TODAY.



## Shure crystal mike

★ Model 730S "uniplex" crystal communication mike has built-in RF filter, swivel head, built-in cable connector, satin chrome finish. Complete with 7-foot shielded cable, and gray desk stand, \$35.50. Shure Brothers, 225 W. Huron St., Chicago, Ill.—RADIO TODAY.



## Lafayette amplifier

★ Model 406T low powered amplifier has 6-watt rating. Response is 50 to 8000 cps. Tone control is provided. One mike, and one phono input, 105 and 62 DB gain respectively. Lafayette Radio Corp., 100 6th Ave., New York, N. Y.—RADIO TODAY.



## Hallicrafter FM-AM tuner

★ Model S-31 tuner covers the BC band of 540 to 1650 kc and the FM band of 40 to 51 mc. Eight tubes are used in the circuit for both systems and selection of the 4.3-mc. FM IF channel or 455 kc. AM IF channel is done by switching. "S" meter is incorporated. 500 and 5000 ohm outputs are provided. Hallicrafters, Inc., 2611 S. Indiana St., Chicago, Ill.—RADIO TODAY.

## Carter dynamotor

★ New line of aircraft type dynamotors made in two frame sizes, 35 and 100 watts output. The 35-watt size weighs only 4 $\frac{1}{2}$  pounds and the 100-watt size, only 7 $\frac{1}{2}$  pounds. Available in variety of output voltages from 135 to 350. List prices vary from \$30 to \$35. Carter Motor Co., 1608 Milwaukee Ave., Chicago, Ill.—RADIO TODAY.





# Want to Knock the Breath Out of a Piece of Paper?

IT'S done nearly every day, in the Utah factory, as an extra precaution against transformer failure in the field. One of the most common causes of failure in ordinary transformers is due to inadequate protection against moisture.

In these torture chambers, Utah Transformers, encased in layers of specially made, moisture-resistant paper, are heated under a vacuum for hours. Thus, all of the air is safely removed from the paper and all of the moisture is evaporated. Only then is the molten wax drawn into the vacuum tank and forced into the emptied

cells of the paper under high pressure. As a result, an interlayer insulation is obtained which is impervious to moisture.



This is but one of the reasons why Utah Transformers have established such outstanding records, even under severe conditions. And why they offer you extra value. Write for the facts about Utah's complete line of transformers. Utah Radio Products Company, 814 Orleans St., Chicago, Ill. Canadian Office: 560 King St., W., Toronto. In the Argentine: Ucoa Radio Products Company, S. R. L. Buenos Aires. Cable Address: Utaradio, Chicago.

\*500 X enlargement of cross section of interlayer insulating paper showing advantages of (A) Utah's vacuum-pressure, complete impregnation over (B) ordinary hot-dip, surface coverage method, in which air and moisture remain in cells.



**TRANSFORMERS**  
SPEAKERS • VIBRATORS • UTAH-CARTER PARTS



Above, more albums go into the luxurious, new record shop at Jackson's, Oakland, Calif.

At left, one of the new sound-proof booths at Castellanos-Molina Corp., NYC, attracts a record buyer.

# DEALERS ADD RECORDS

*Disc volume runs high as retailers expand their stocks and displays*

At right, new disc stock at Kirk Johnson's, Lancaster, Pa., is sampled in window.

Below, the freshly decorated Circle Record & Radio Shop, NYC, has extra space for booths, albums, and accessory displays.

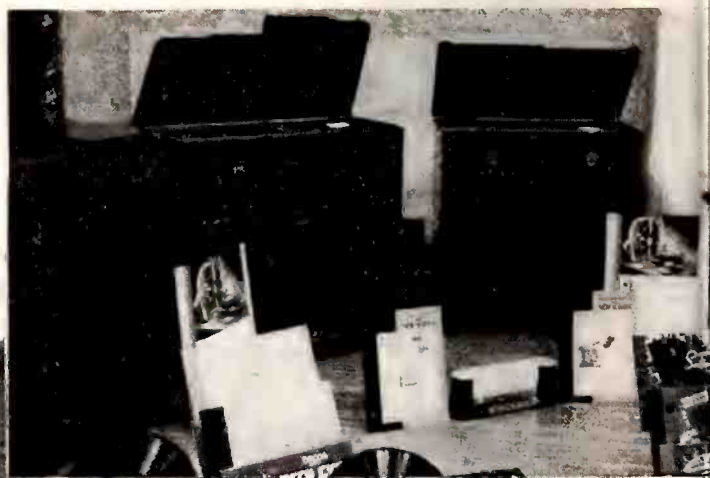

## THOSE FINE POINTS IN KEEPING YOUR RECORD PROFITS UP

Particular success in the retail radio-phonograph business comes from paying close attention to every detail. Every item in the music department should be merchandised. Not just the records and de luxe combinations should get real sales effort, but the smaller essentials and accessories that go with recorded music.

And one of the details is the phonograph needle. Some 75,000,000 records were wrapped up last year, and 900,000 phono-radio combinations were sold. The latter figure is double the total for last year. It's a trend, and one way to keep it going full blast is to give proper attention to the tiny point that rides in the groove of the record.

In a new review of the needle business today, a number of "hints for dealers" are revealed. You start with the principles.

A retailer should realize that what a customer may expect in a needle is (a) good reproduction, (b) minimum record wear, (c) low surface noise and (d) convenient durability.

A record man should also be hep to a certain amount of technical information, such as the character of the record groove, the fundamental nature of point materials and metals used for needles, the significance of the polish and the shape of the needle, the importance of the weight of the pickup, the angle at which the needle plays, etc.

(Did you know that the record groove is about .065 in. across the top and .002 in. deep? Or that the needle travels about 595 ft. in playing a 10 in. record?)

### PROFITABLE POINTS

He should likewise be aware of the methods used by his manufacturers to insure the uniformity of the needle point. For example, some are "Micro-spectred" or "Shadowgraphed" at the factory as a positive check on the shape of the playing tip.

Another requirement of the disc merchandiser is that he keep up-to-the-minute on developments released by the manufacturers in the field. New products and their customer-getting possibilities. Announcements on the replacement sales possibilities of the new lightweight pickups with permanent sapphire styli, for instance, and the public interest created in the photo-electric record player—the "music on a beam of light" device. When people are interested in better equipment, that's the time to sell them—  
at a good profit.

Dealers need, too, a demonstration routine that will illustrate to customers the details of surface noise, worn needle points, record wear, etc. Some dealers, for example use magnifying glasses to show prospects the point of a needle after a fixed number of playings. Some stores make a habit of using a good symphonic disc on which to demonstrate a number of different

(Continued on page 48)

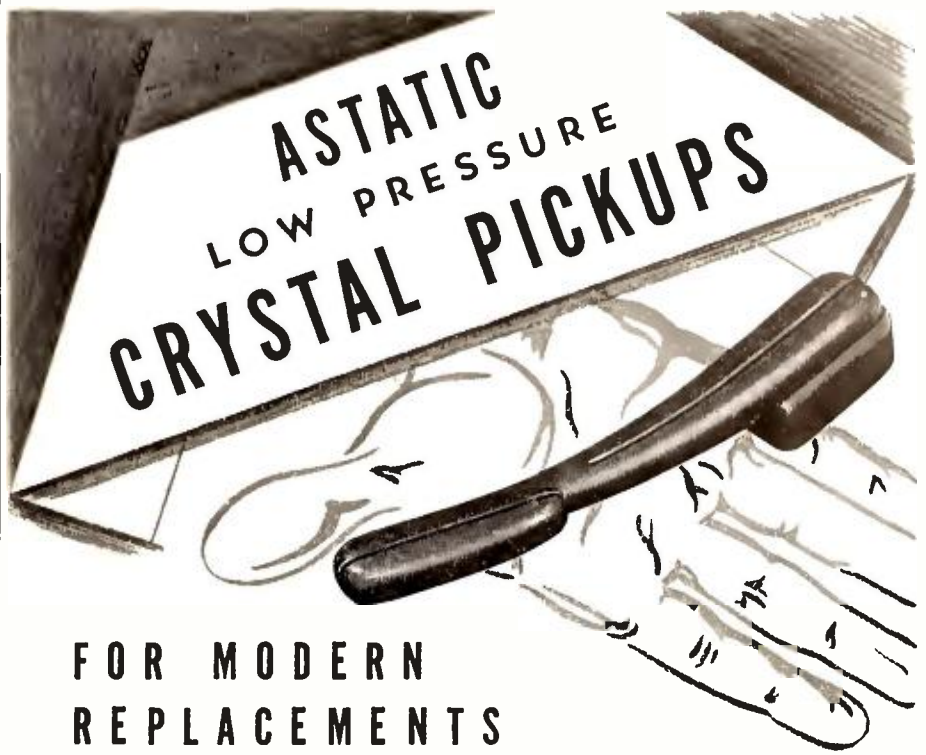

## FOR MODERN REPLACEMENTS

• Here's new business . . . good business . . . easy to get. These pickups have so many advantages . . . so many fine selling points . . . that only "low pressure" selling is necessary to convince a customer of the wisdom of modernizing phonograph equipment with Astatic's New Low Pressure Crystal Pickup. With only one-ounce stylus pressure on the record, scarcely more than one-third the conventional weight, records will last a lifetime. Built-in, permanent sapphire stylus eliminates the necessity of ever changing needles, and reproduction is greatly improved with the elimination of surface noise and distortion.

There's new business to be had! Every lover of recorded music, especially those possessing symphonic, operatic and other prized recordings is a potential customer. Department stores demonstrating records, schools desirous of prolonging the life of educational recordings, and many others, are all prospects for Low Pressure Pickup business.

Astatic Crystal Products  
Licensed Under Brush  
Development Co. Patents

Write for special literature. All Pickups are wired for quick and easy installation.

In Canada:  
Canadian Astatic, Ltd.,  
Toronto, Ont.

# ASTATIC

ASTATIC MICROPHONE LABORATORY, Inc.  
YOUNGSTOWN, OHIO

# NEW PRODUCTS

Equipment from the manufacturers  
for Spring sound, service, and sales.

## Talk-A-Phone record player

★ Portable record player and amplifier, G-44, plays 10 and 12 in. records with lid closed. Amplifier has built-in 3-tube inverse feedback circuit. PM dynamic speaker, self-starting motor, crystal pickup. Striped airplane luggage. Removable compartment for eight 10-in. records. 110-120 v., 60 cycles, AC. Talk-A-Phone Mfg. Co., 1219 W. Van Buren, Chicago, Ill.—RADIO TODAY.

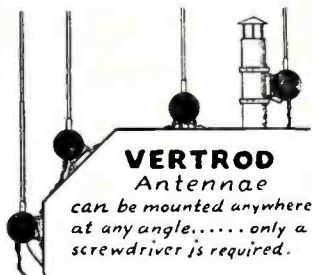

## Vertrod antenna

★ Pole type antennas designed for mounting at any angle in small space, has balanced line-to-ground impedances for noise reduction. Frequency range of 500 kc. to 22 mc. with the special transformers used. Model 101 lists at \$8.50 and special FM antenna 102, at \$12.00. Vertrod Mfg. Co., 132 Nassau St., New York, N. Y.—RADIO TODAY.

## Fada 33 series

★ Camera-type 4-tube superhet battery portable, 4 colors—black, blue, maroon or genuine cowhide (tan.) Weighs 4½ lbs. 8 in. x 4¼ in. x 4¼ in. deep. (Plays when lid is opened. Double-tuned iron-core IF. 3½ in. PM speaker. Built-in Fa-da-scope Hi-Q antenna. \$20. Cowhide, \$25. Fada Radio & Elec. Co., Inc., 30-20 Thompson Ave., L. I. City, N. Y.—RADIO TODAY.



## Eagle Fluralamp

★ Adaptor type fixture for fluorescent lamps has swivel plug for easy attachment to any AC or DC outlet. Hanging lugs on each end help support unit. Power factor corrected control device. Number 556 for 18-inch lamp, and 550 for 24-inch lamp. Eagle Electric Mfg. Co., 59-79 Hall St., Brooklyn, N. Y.—RADIO TODAY.

## Andrea Portagram

★ Model G42A portable electric phonograph has two tubes, 6½-inch PM speaker, tone and volume control outside the case for use when lid is closed. Plays 10 and 12-inch records with lid closed. Finished in tan simulated leather. Andrea Radio Corp., 48-20 48th Ave., Woodside, N. Y.—RADIO TODAY.

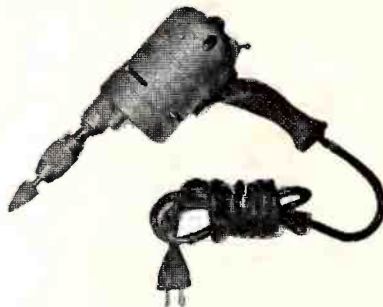

## Paramount electric drill

★ Portable electric drill operates from AC or DC power. Chuck capacity is ¼-inch. Ball-bearing thrust, geared drive. Price, \$7.95. Included with drill is set of sanding discs, grinding wheel, twist bits, mounted brush, polishing wheel. Paramount Products Co., 545 5th Ave., New York, N. Y.—RADIO TODAY.



## Aerovox capacitors

★ Plug-in filter capacitor units now available as regular stock items. Electrolytic units have octal base, non-corrosive connections between plates and base pins. Designed for quick replacement service in mobile and compact equipment. Aerovox Corp., New Bedford, Mass.—RADIO TODAY.

## Radex coils

★ Replacement coils for RF, oscillator and Ant. circuits have iron core inductance adjustments to permit universal replacement and correct tracking. Available in shielded and unshielded types, these coils are claimed to service 90 per cent of receivers. Radex Corp., 1733 Milwaukee Ave., Chicago, Ill.—RADIO TODAY.

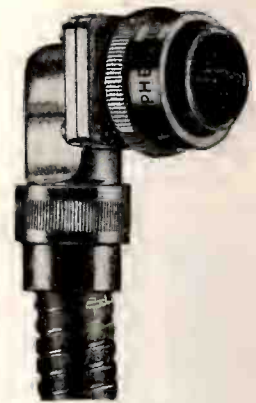

## Amphenol connectors

★ Angle cable-plug available in 18 sizes with 1 to 42 contacts. Will fit conduit as shown, shielded cables or portable cords. In 5 to 200 amp. sizes. Type AN 9534 American Phenolic Corp., 1250 Van Buren St., Chicago—RADIO TODAY.

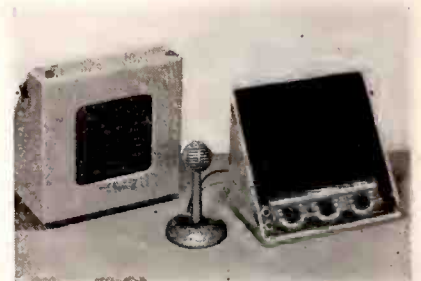

## Erwood portable amplifier

★ New 8-watt system included 10 inch PM speaker, desk type crystal mike, five-tube amplifier. Variable tone control and phono input channel provided. All parts carried in convenient case. List, less tubes, \$49.50. Erwood Sound Equip. Co., 223 W. Erie St., Chicago, Ill.—RADIO TODAY.

## Hamilton Radio to Make Sets

New entry into the radio set manufacturing business is Hamilton Radio Corp., with headquarters at 142 W. 26th St., New York City. The firm succeeds the Namco Mfg. Co., and is headed by Maurice Fabricant, who has had wide experience in the radio field, mostly as a radio manufacturer in Paris, France.

The new company will bring out a complete line of receivers, including 10 different models, with miniature 3-way sets and automatic combinations among them.

Percy L. Schoen, who previously merchandised "Bestone" radios in England and also worked with Namco, is vice-president of the new firm. Secretary and treasurer is Paul Fabricant, brother of Maurice, who is also a Paris radio expert. While in France, he represented American radio firms there, including Weston, DuMont and General Radio.

## Gilmour Joins Farnsworth Board

Lloyd S. Gilmour of New York City has been elected to the board of directors of Farnsworth Television & Radio Corp., Ft. Wayne, Ind., according to word from president E. A. Nicholas. Mr. Gilmour is senior partner of Eastman, Dillon & Co.

Besides Mr. Nicholas and Mr. Gilmour, the Farnsworth board members include J. B. McCargar and George Everson, San Francisco; John F. Wharton and Burton A. Howe, New York; and Philo Farnsworth and Charles M. Niezer, Ft. Wayne.

## Pacific Coast Servicemen Get Money-Making Hints

Radio men on the West Coast were treated to a new series of illustrated addresses on profitable angles of servicing last month when George C. Connor, Hygrade Sylvania commercial engineer, appeared there in the California, Washington and Oregon sessions of the Sylvania Service Schools.

Of special interest to the servicemen attending the Fresno and Oakland, Calif., meeting, sponsored by DeJarnatt Wholesale Radio Parts Co., was the innovation of writing with fluorescent chalk on a white board by Mr. Connor to diagram wiring of radio circuits. The room was totally dark and the board illuminated by ultra violet ray beams.

Meetings were sponsored by Sylvania jobbers in each locality. The distributors were represented at the meetings by members of their respective organizations, namely; Frank A. Nelson of the Frank A. Nelson Co.; Paul Hanson of E. M. Nelson Co.; Ed Manfield of Cook Nichols Co.; Howard Taylor of Radio Supply; Larry Lynde and George Mason of Fred S. Dean Co.; Lloyd Wacaser, Tom Walters, Stewart Richmond of DeJarnatt Wholesale Radio Parts Co.; W. D. Brill, Ralph Seitz, Al Syles, Paul Seitz of W. D. Brill Co.; Mr. Hay of Carlson, Hatton & Hay Co.; Tom Morgan of

Northwest Radio Supply Co.; Virgil Cowen of Stubbs Electric Co.; Jim Walkus of Walkus Supply Co.; L. G. Reynolds and Frank Wedel of Northern Radio Co.; and Morris Willis of Spokane Radio.

Representing Sylvania and assisting Mr. Connor in conducting the classes were western sales representative of Sylvania Pacific, Perry Demarest, his assistant W. G. Patterson, Pacific northwest Sylvania representative Art Detsch, and his assistants Don Brown and Al Willoughby.

Jobbers in the area reported a strong upturn in radio business, and cited the U. S. Defense spending as a chief reason. It was noted that large numbers of servicemen have joined the Navy and Army forces.

## Crosley Gets 2,408 New Radio Dealers

At the close of the nation-wide "dealer-getting" contest sponsored by the Crosley Corp. among its distributors, it was revealed that 2,408 radio dealers had been added.

For adding 200 dealers, the Crosley Distributing Corp., New York City, was awarded one grand prize; the other award went to Associated Wholesale Electric Co., San Francisco, for the biggest increase in new dealers. Zone and district managers in these areas were given prizes—to N. C. MacDonald in the East, and to Sam G. Mitchell and H. F. Jaax in the West. Plaques, trophies and other prizes were involved.

## General Electric Introduces



### NEW Tube Checker

MODEL TC-2

The Model TC-2 includes all existing American sockets with some extra spares. Filament Voltage—complete coverage for 1 1/2 volts to 117 with five spare positions. Short Test—Standard RMA with rejection at .25 megohm. Two-color panel—beige and maroon. Weight—16 lbs.

### NEW Unimeter

MODEL UM-1

A precision instrument for accurate service work. The large meter is calibrated and laid out so that the inclusion of the many ranges are very distinguishable to reduce the possibility of error in reading. Actually 29 meters in 1! Two-color panel—beige and maroon. Weight—9 1/4 lbs.



**FREE**  
VALUABLE  
TECHNICAL  
TUBE  
MANUAL

Mail the Coupon!

General Electric Company, Tube Sales Section,  
Radio and Television Department,  
Bridgeport, Conn.

Please send me, without cost or obligation, the  
new G-E Manual of Radio Tube Specifications.

Name.....

Address.....

**GENERAL ELECTRIC**

# HOW TO RE-SET PUSH

**Simplified set-up procedure for six basic type of mechanical and electro-mechanical push button systems.**

The "big shift" of radio push-buttons next month will bring into your hands a group of mechanical and electrical tuning systems which you have not worked with for some time. The following diagrams and set-up directions will familiarize you with the popular mechanisms.

Several general rules apply to setting-up of all push-button mechanisms. First, allow the set to warm-up for ten to twenty minutes before making any adjustments. During this time you

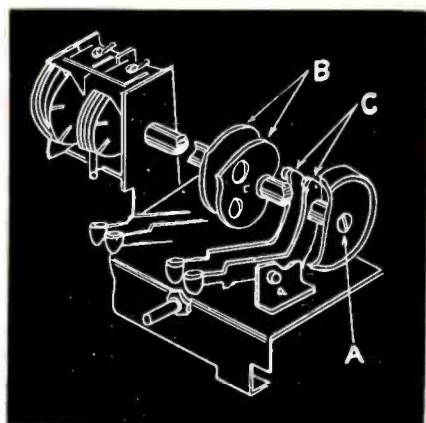

Fig. 1—Cam and lever mechanical system. Loosen cams, press button, tune in station, tighten cam lock.

can clean the chassis and speaker, make a general inspection of the condition of the set and estimate any repair work if it is necessary. If a push-button alignment device is used, allow it to warm-up during the same period.

## USING YOUR OSCILLATOR

Second, be sure the adjustments you make are secure and will not shift during continued use. This means careful re-checking of all set-ups by actually operating the mechanism several times. Screws, knobs, and other adjusting devices should be tight enough to hold their positions.

Where it is necessary to reset push-buttons in advance of the March 29th change-over date, some standard frequency source will be necessary. One method which may be used is that of re-calibrating your signal generator for the broadcast band by beating its signal against the present known frequency broadcast stations which you can receive in your locality. Plot the dial readings of your signal generator against the frequencies of broadcast stations on the largest sheet of cross-sectioned paper you can get. Get as many points as possible as a check. The best time for this will be late in

the evening, when with a good receiver, plenty of known frequencies can be logged. Draw straight lines between the successive points where they are only a few kilocycles apart.

Your re-calibrated oscillator should then be used to set-up a push-button alignment oscillator which will hold calibration over long periods of time. These are available from several manufacturers. It is important that every means of checking the frequencies should be used. Crystal controlled calibrators which have numerous harmonics will also give a double check, usually at 100 kc. intervals.

## CAM AND LEVER TYPE

This mechanical type of mechanism is usually found on the smaller table model sets with four buttons. It is characterized by a downward lever type action of the button. The cut-away view Fig. 1 shows the important parts of the tuner. The roller on a push-button lever (C) is pressed against its respective heart-shaped cam (B) when the button is moved downward. The pressure of the roller turns the cam to a "dip" or low point, thus tuning the gang condenser. To set-up these buttons; 1. loosen set screw or locking device on the cam shaft (A). 2. Press down any button for which an adjustment is to be made. 3. Manually tune in station to best position. 4. Set up other buttons in similar manner. 5. Lock cams on shaft.

Some receivers using the cam and lever system use the tuning knob and

a gear system to "un-lock" the cams for adjustment. The knob is pressed inward until it engages the releasing mechanism, and is turned to the left until the cams can be adjusted. The station set-up procedure is the same, however. Other variations involve the locking of the cams with special screws or knobs. Another popular type uses a snap-in button in the dial escutcheon to cover a locking screw. Remove the button, and insert a screw driver. Press in, and turn locking screw to left until cams are free for adjustment.

## ROCKER BAR TYPE

Another mechanical push-button tuner similar to the cam and lever type uses a rocker bar or plate attached to a sector gear which in turn drives the tuning condenser. Tuning to a particular station is accomplished by pressing firmly on a button which has an arm-type cam attached at a particular angle to the button rod. The cam pressing against the rocker bar tends to align it at the same angle thereby turning the condenser shaft to the predetermined position. See the photo Fig. 2 of a typical mechanism. Springs are used to return the buttons to their normal "out" position after a station has been tuned. No change-over between manual and button tuning is required.

The type of unit shown in Fig. 2 is set-up as follows. 1. Pull the push-button from the push arm. 2. Loosen the cam locking screw  $\frac{1}{2}$ -turn. 3. Using the manual tuning, select the de-

Fig. 2—Rocker-bar mechanical system is adjusted by loosening locking screws a half turn, pressing the push-button and holding it while tuning desired station manually, then locking the cam holding screw. Repeat for other buttons.

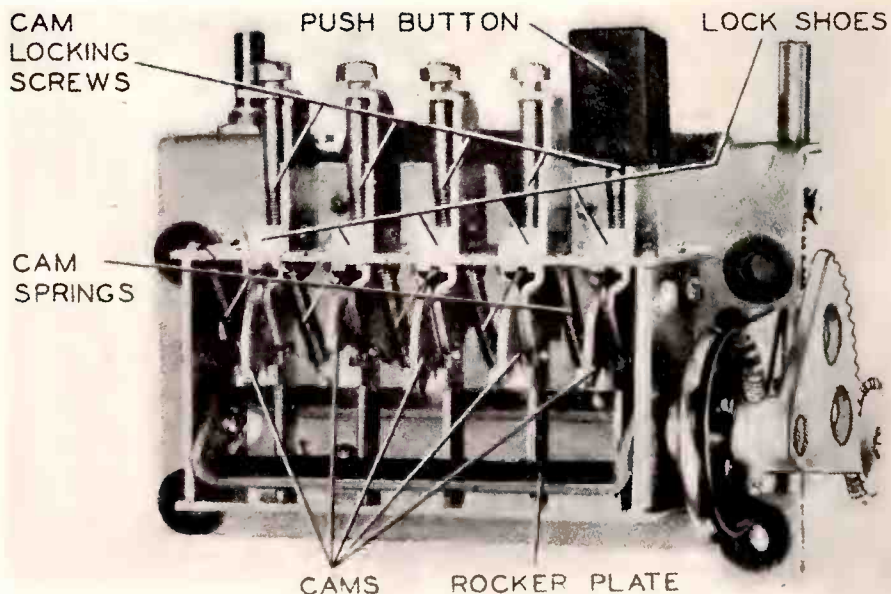

# UTTONS

sired station carefully. 4. Press in the push arm as far as it will go and accurately re-tune the station. 5. While holding the push-button down, tighten the cam locking screw. 6. Replace push-button knob and proceed to next button for set-up.

## OTHER ROCKER TYPES

Other types of rocker bar assemblies have the cam locking screws integral with the button. The cams are released by turning the buttons counter-clockwise  $1\frac{1}{2}$  turns. The set-up is exactly the same as described above. The locking screws on other types are exposed by removing the station name tabs from either the ends of the buttons or the escutcheon plate. Still others are located alongside the push rods and are exposed by removing the button trim plate or escutcheon.

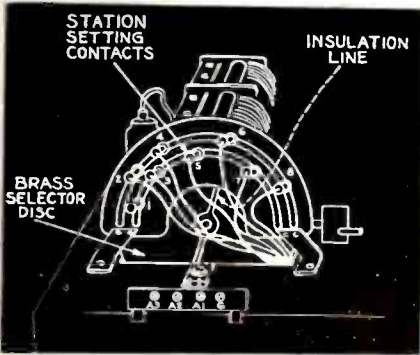

Fig. 4—Electro-mechanical split selector disc types adjusted by moving contact buttons 1, 2, 3, etc.

## TELEPHONE DIAL TYPES

The revolving telephone dial-type tuner is another mechanical system which uses stopping pins to return the gang condenser to its correct position.

The diagram of Fig. 3 shows a cut-away view of this mechanism. The push-buttons are small spur gears with a crank-shaped pin fastened firmly to the inner end. The plate which holds the push buttons has mating teeth to hold the buttons in a particular position. A metal disc with a curved section cut from it to permit the removal of one button at a time and a clamping nut are the adjusting parts.

When a button is pressed and the dial is rotated in either direction, the bent pin on the back of the depressed button comes to rest against a metal vane which acts as a stop. The gang condenser is attached to the dial mechanism and is turned simultaneously.

To set up the buttons for this mechanism, proceed as follows. 1. Remove the bakelite cover plate by removing the large face nut in the center. 2. Put thin metal disc with circular notch on the hub of the dial and replace the face nut. This notched plate is used only to hold the buttons during set-up.

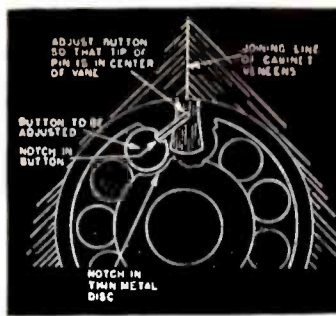
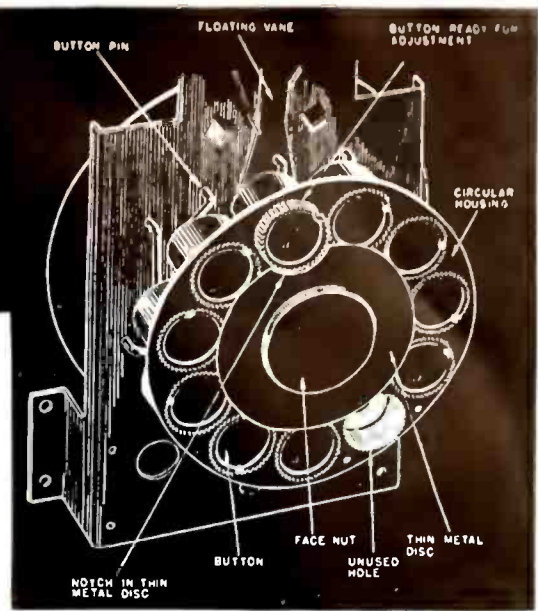

Fig. 3—Mechanical telephone dial type. Crank pin on each button is adjusted to stop dial and condenser at correct position when housing is turned. Tune station manually and set top button pin to vertical center line. Set button forward or backward one tooth at a time until station is tuned sharply.



The springs back of the buttons may throw them out of the holding ring unless the set is tilted backward during the removal of the bakelite housing. Notice that one hole is not used in the revolving plate. 3. Select the button whose frequency range will include that of the station to be reset. 4. Carefully rotate the thin notched plate after slightly loosening the face nut, until the notch is in line with the button to be adjusted. Hold each button with your finger as the disc is moved by, or the button will spring out and lose its setting. 5. Manually tune the station to be set-up. The button being set-up will be near the top of the housing. 6. Insert button so that the tip of the crank-pin is in line with the center of the metal vane. This is approximately the same as the joint in the cabinet veneer. The large notch in the rim of the button locates the tip of the pin. See Fig. 3. The station must remain perfectly tuned during this operation. 7. Move the notched plate slightly to hold the button just set. 8. Check the set-up by dialing the station in both the clock-wise and counter-clock-wise directions. If the station is not sharply tuned-in, carefully move the button one tooth at a time until correct tuning is obtained. 9. Adjust the other buttons in the same manner. 10. Tilt the set backward, carefully remove the notched metal plate and replace the bakelite cover so that the blank space covers the unused hole in the button holder. Care must be used to prevent the buttons from springing out of the housing.

## SPLIT-SELECTOR DISC TYPE

Two buttons with extra long crank-pins are sometimes used for reaching a particular station. These are used only where the short pins do not reach. It is important that the arm of the pin be either horizontal or pointing at some angle away from the hub (viewed when it has selected a station). This is necessary to prevent interference between the pins and other parts of the mechanism.

Various electrical tuning mechanisms employ a metal disc attached to the condenser gang and tuning motor, which is divided into two insulated sections. A group of station contact buttons are adjustable in concentric semi-circular tracks. See Fig. 4 for a layout of this tuner.

To set-up stations proceed as follows. 1. After the set has warmed up, press the "dial tuning" button and manually tune the lowest frequency station to be reset. 2. Hold down the dial tuning button and press the corresponding station button. Both will remain in. 3. Move the correct contact pin until it is directly on the narrow strip of insulation dividing the metal disc. The center dial lamp will go out when the contact is adjusted correctly. The contact buttons are counted from left to right when facing the back of the set. 4. Press down any other button to release the dial and button just set up. Pressing the button just adjusted will re-tune the station. 5. Proceed with the other buttons in the same manner.

## OTHER TYPES

The divided selector disc should be adjusted so that the insulation line is horizontal with the dark material at the left end when the condenser is full meshed and viewed from the back of the set. Do this, if necessary, before adjusting the buttons.

The Stewart-Warner "magic key-  
(Continued on page 42)

Fig. 5—Four steps in setting-up "magic keyboard." Unlock mechanism, tune station, push knob in, pull out and lock mechanism. See text.

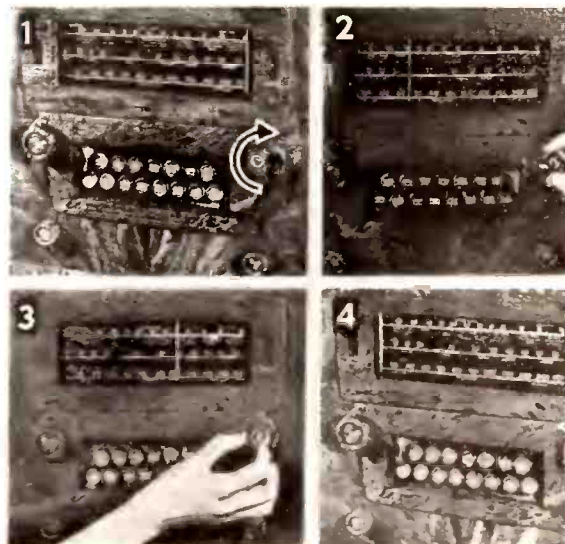

# HOW TO RE-SET PUSH-BUTTONS

Simplified set-up procedure for six basic type of mechanical and electro-mechanical push button systems.

The "big shift" of radio push-buttons next month will bring into your hands a group of mechanical and electrical tuning systems which you have not worked with for some time. The following diagrams and set-up directions will familiarize you with the popular mechanisms.

Several general rules apply to setting-up of all push-button mechanisms. First, allow the set to warm-up for ten to twenty minutes before making any adjustments. During this time you

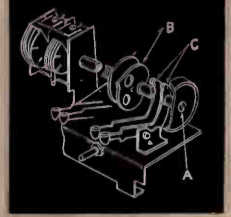

Fig. 1—Cam and lever mechanical system. Loosen cams, press button, tune in station, tighten cam lock.

can clean the chassis and speaker, make a general inspection of the condition of the set and estimate any repair work if it is necessary. If a push-button alignment device is used, allow it to warm-up during the same period.

## USING YOUR OSCILLATOR

Second, be sure the adjustments you make are secure and will not shift during continued use. This means careful re-checking of all setups by actually operating the mechanism several times. Screws, knobs, and other adjusting devices should be tight enough to hold their positions.

Where it is necessary to reset push-buttons in advance of the March 25th change-over date, some standard frequency source will be necessary. One method which may be used is that of recalibrating your signal generator for the broadcast band by beating its signal against the present known frequency broadcast stations which you can receive in your locality. Plot the dial readings of your signal generator against the frequencies of broadcast stations on the largest size of cross-sectioned paper you can get. Get as many points as possible as a check. The best time for this will be late in

the evening, when with a good receiver, plenty of known frequencies can be logged. Draw straight lines between the successive points where they are only a few kilocycles apart.

Your recalibrated oscillator should then be used to set-up a push-button alignment oscillator which will hold calibration over long periods of time. These are available from several manufacturers. It is important that every means of checking the frequencies should be used. Crystal controlled calibrators which have numerous harmonics will also give a double check, usually at 100 kc. intervals.

## CAM AND LEVER TYPE

This mechanical type of mechanism is usually found on the smaller table model sets with four buttons. It is characterized by a downward lever type action of the button. The cut-away view Fig. 1 shows the important parts of the tuner. The roller on a push-button lever (C) is pressed against its respective heart-shaped cam (B) when the button is moved downward. The pressure of the roller turns the cam to a "dip" or low point, thus tuning the gang condenser. To set-up these buttons: 1. Loosen set screw or locking device on the cam shaft (A). 2. Press down any button for which an adjustment is to be made. 3. Manually tune in station to best position. 4. Set up other buttons in similar manner. 5. Lock cams on shaft.

Some receivers using the cam and lever system use the tuning knob and

a gear system to "un-lock" the cams for adjustment. The knob is pressed inward until it engages the retaining mechanism, and is turned to the left until the cams can be adjusted. The station set-up procedure is the same, however. Other variations involve the locking of the cams with special screws or knobs. Another popular type uses a snap-in button in the dial escutcheon to cover a locking screw. Remove the button, and insert a screw driver. Press in, and turn locking screw to left until cams are free for adjustment.

## ROCKER BAR TYPE

Another mechanical push-button tuner similar to the cam and lever type uses a rocker bar or plate attached to a sector gear which in turn drives the tuning condenser. Tuning to a particular station is accomplished by pressing firmly on a button which has an arm-type cam attached at a particular angle to the button rod. The cam pressing against the rocker bar tends to align it at the same angle thereby turning the condenser shafts to the predetermined position. See the photo Fig. 2 of a typical mechanism. Springs are used to return the buttons to their normal "out" position after a station has been tuned. No change-over between manual and button tuning is required.

The type of unit shown in Fig. 2 is set-up as follows. 1. Pull the push-button from the push arm. 2. Loosen the cam locking screw  $\frac{1}{2}$ -turn. 3. Using the manual tuning, select the de-

Fig. 2—Rocker-bar mechanical system is adjusted by loosening locking screws a half turn, pressing the push-button and holding it while tuning desired station manually, then locking the cam holding screw. Repeat for other buttons.

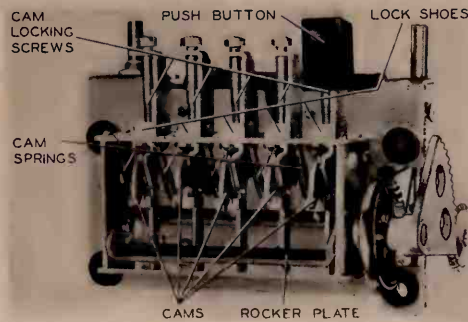

CAMS ROCKER PLATE

sired station carefully. 4. Press in the push arm as far as it will go and accurately re-tune the station, holding the push-button down, tighten the cam locking screw. 6. Replace the cam locking knob and proceed to next button for setup.

## OTHER ROCKER TYPES

Other types of rocker bar assemblies have the cam locking screws in contact with the button. The cams are released by turning the buttons counter-clockwise  $\frac{1}{2}$  turns. The setup is exactly the same as described above. The locking screws on other types are exposed by removing the station name tabs from either the ends of the buttons or the escutcheon plate. Still others are located alongside the push rods and are exposed by removing the button trim plate or escutcheon.

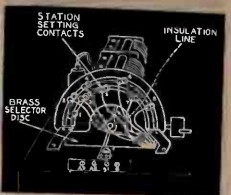

Fig. 4—Electro-mechanical split selector disc types adjusted by moving contact buttons 1, 2, 3, etc.

## TELEPHONE DIAL TYPES

The revolving telephone dial-type tuner is another mechanical system which uses stopping pins to return the gang condenser to its correct position. The diagram of Fig. 3 shows a cut-away view of this mechanism. The push-buttons are small spur gears with a crank-shaped pin fastened firmly to the inner end. The plate which holds the push buttons has mating teeth to hold the buttons in a particular position. A metal disc with a curved section cut from it to permit the removal of one button at a time and a clamping nut are the adjusting parts.

When a button is pressed and the dial is rotated in either direction, the bent pin on the back of the depressed button comes to rest against a metal vane which acts as a stop. The gang condenser is attached to the dial mechanism and is turned simultaneously. To set up the buttons for this mechanism, proceed as follows. 1. Remove the bakelite cover plate by removing the large face nut in the center. 2. Put thin metal disc with circular notch on the hub of the dial and replace the semi-circular plate used in the face nut. This notched plate is used only to hold the buttons during setup.

Fig. 3—Mechanical telephone dial type. Crank pin on each push-button is adjusted to stop and condenser at correct position when housing is turned. Tune station manually and set center top button pin to vertical center line. Set button forward or backward one tooth at a time until station is tuned sharply.

The springs back of the buttons may throw them out of the holding ring unless the set is tilted backward during the removal of the bakelite housing. Notice that one hole is not used in the revolving plate. 3. Select the button whose frequency range will include that of the station to be reset. 4. Carefully rotate the thin notched plate after slightly loosening the face nut, until the notch is in line with the button to be adjusted. Hold each button with your finger as the disc is moved by, or the button will spring out and lose its setting. 5. Manually tune the station to be set-up. The button being set-up will be near the top of the housing. 6. Insert button so that the tip of the crank-pin is in line with the center of the metal vane. This is approximately the same as the joint in the cabinet vane. The large notch in the rim of the button locates the tip of the pin. See Fig. 3. The station must remain perfectly tuned during this operation. 7. Move the notched plate slightly to hold the button just set. 8. Check the set-up by dialing the station in both the clockwise and counter-clockwise directions. If the station is not sharply tuned, carefully move the button one tooth at a time until correct tuning is obtained. 9. Adjust the other buttons in the same manner. 10. Tilt the set backward, carefully remove the notched metal plate and replace the bakelite cover so that the blank space covers the unused hole in the button holder. Care must be used to prevent the buttons from springing out of the housing.

## SPLIT-SELECTOR DISC TYPE

Two buttons with extra long crank-pins are sometimes used for reaching a particular station. These are used only where the short pins do not reach. It is important that the arm of the pin be either horizontal or pointing at some angle away from the hub (viewed when it has selected a station). This is necessary to prevent interference between the pins and other parts of the mechanism.

Various electrical tuning mechanisms employ a metal disc attached to the bakelite cover plate by removing the large face nut in the center. 2. Put thin metal disc with circular notch on the hub of the dial and replace the semi-circular plate used in the face nut. This notched plate is used only to hold the buttons during setup.

To set-up stations proceed as follows. 1. After the set has warmed up, press the "dial tuning" button and manually tune the lowest frequency station to be reset. 2. Hold down the dial tuning button and press the corresponding station button. Both will remain lit. 3. Move the correct contact pin until it is directly on the narrow strip of insulation dividing the metal disc. The center dial lamp will go out when the contact is adjusted correctly. The contact buttons are counted from left to right when facing the back of the set. 4. Press down any other button to release the dial and button just set up. Pressing the button just adjusted will re-tune the station. 5. Proceed with the other buttons in the same manner.

## OTHER TYPES

The divided selector disc should be adjusted so that the insulation line is horizontal with the dark material at the left end when the condenser is fully meshed and viewed from the back of the set. Do this, if necessary, before adjusting the buttons.

The Stewart-Warner "marle key" (Continued on page 42)

Fig. 5—Four steps in setting-up "magic keyboard." Unlock mechanism, tune station, push knob in, pull out and lock mechanism. See text.





## RE-SETTING PUSH BUTTONS

(Continued from page 41)

board" mechanism is a combination of electrical and mechanical units. To set-up the buttons, see Fig. 5 and proceed as follows. 1. Remove the tuning knob by pulling it out from the panel and pull out the set-up knob on the same shaft as far as it will go. Rock the knob slightly to engage the gears. Turn the knob clockwise as far as it will go. During this operation, the dial pointer will move to the right and stop. The set-up knob is rotated about  $\frac{3}{4}$  of a turn beyond this point. 2. Push the button that is to be reset, being sure it is all the way in. Using the set-up knob, manually tune the desired station for best reception. This button is set as soon as another button is pressed. Proceed to set the remaining buttons by pressing each down and tuning the desired station. 3. To release the last button pressed, push the set-up knob on the tuning shaft back into the cabinet as far as it will go and then pull it out again, being sure to rock the knob to mesh the gears. 4. To lock the mechanism, turn the set-up knob counter clockwise until a definite stop is reached after the dial pointer moves to the left end of the scale. The set-up knob is pushed back in and the tuning knob replaced. This completes the set-up procedure.

### KEY AND DISC ELECTRIC TYPE

The electric tuning mechanisms which travel to one end of the dial scale and then return to the desired station are usually arranged like the system of Fig. 6.

Set up as follows. 1. Warm-up the set, put the range selector on standard broadcast, and the control knob to "Electric". 2. Press the first button to be set, and wait until the pointer stops. 3. Turn the control knob to "Manual". 4. Put the set-up pin into the adjustment strip above the selector disc corresponding to the particular push-button. Be sure pin is well

down into the notch. 5. Tune the receiver carefully to the desired station. 6. Remove the set-up pin. 7. Turn control to "Electric". This button is now properly adjusted and the others may be set-up by holding the correct disc with the pin while tuning the station manually.

The newer types of inductance and capacity trimming units for push-button receivers are simple to re-adjust. The mica trimmers or iron cores are adjusted for best reception on the particular station within their tuning range. The oscillator trimmer is adjusted first, and then the detector and RF trimmers are peaked.

### Tube Failures in AC/DC Battery Portables

Burned-out filaments in the tubes used with portables are one of the chief complaints in these sets. The AC/DC, battery type in particular give trouble because of the usual surges in voltages common with half-wave rectifiers.

The four, five, or six tubes are connected in series with a voltage dropping resistor across the output of the rectifier. A filter capacitor of 50 to 100 mfd. is connected across the series group of filaments. If one of the tube filaments burns out, the filter condenser charges to approximately 150 volts. If a good tube is then installed, the 150 volts across 4 or 5 1.5 volt tubes will quickly burn-out one or more filaments. Even of the line power is off, the condenser may have sufficient charge to blow the tubes.

### CONDENSER FAILURE

In some circuits, the high capacity condenser is of 10 or 25 volt rating in which case it will fail if one of the tubes burns out and allows the full rectified voltage to build up across it. If this condenser is out, it should be replaced with one capable of withstanding the full rectified voltage. Since the power tube is located at the positive end of the string to obtain bias, the plate and screen current from this

tube would have to flow back through the filaments of the other tubes if a bleeder resistor to ground were not used. 1000 ohms is the usual value. The best type of circuit will have a bleeder resistor across the high capacity condenser which will prevent a tube from being blown due to a high charge on the condenser. New tubes put in while the set is turned on the line power may not be protected however.

In any of the combination battery portables, the filament circuit should be studied so that you will know exactly what happens when tubes are removed or burned out. The set should be disconnected from the line and the filter capacitor shorted before any tubes are replaced.

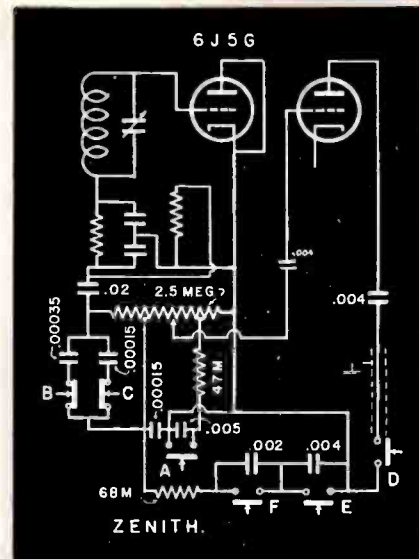

### Push-button Tone Control on Zenith Models

The Radiorgan tone control on many Zenith models is shown in the accompanying diagram. A 6J5G is used as a diode second detector. A separate triode is used as an audio driver. The six push-buttons give 65 different combinations of tone. Closing switch A gives low bass. Switch B is "treble," C is for "voice," D closes is "normal," E is "alto," and F for "bass." The switches control the shunting across the volume control and the feedback from the plate circuit of the audio driver.

### RCA Model 15BP Changes

Better reproduction of the high frequencies will result if the RF by-pass capacitor across the first AF output is changed from 390 mmfd. to 100 mmfd.

Cases of hum in this model can be reduced by putting a shield around the 1H5GT and securely grounding, or by adding a filter network to the plate circuit of that tube. Add a 100M ohm resistor in series with 1H5GT plate supply and by-pass the plate end of the new resistor to ground through 0.1 mfd.

Dial cord slippage may be eliminated by taking an extra turn around the drive shaft without lengthening the cord.

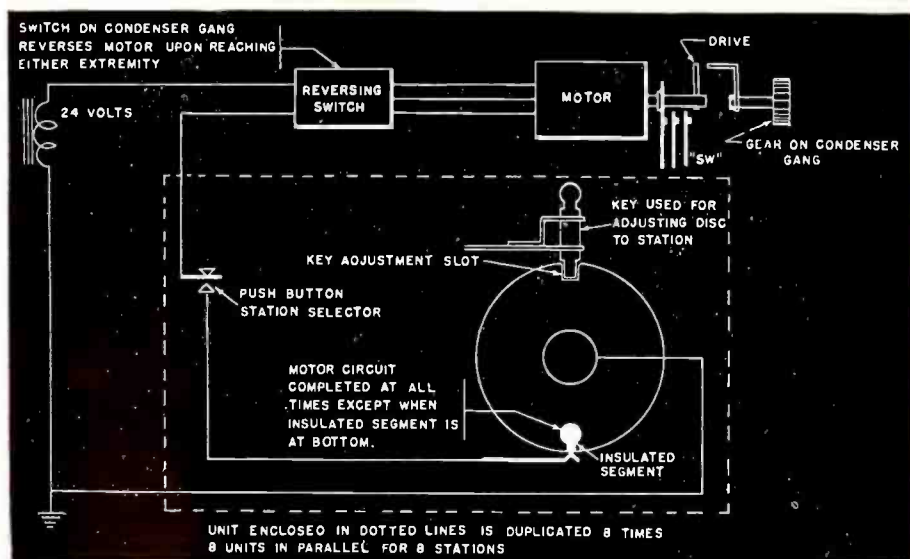

Fig. 6—Notched disc electric type has separate disc for each push-button. To set-up, push button and wait until motor stops; drop key into notch, tune station manually, remove key from notch, continue with other buttons.



## HERE'S A BIG SAVING

for Any Serviceman Who Makes Frequent Volume Control Replacements

### WHAT IS IT?

This IRC Master Radiotrician's Control Kit, factory packed with 18 Type D Universal Controls, 6 switches and 5 extra shafts of special design (1) Enables you to give better, faster service; (2) Saves time and cost by eliminating frequent need for ordering special controls; (3) Avoids frequent trips to your jobber; and (4) Helps systematize your shop by supplying a good-looking container that enables you to tell at a glance just what controls should be re-ordered. *You can actually meet from 60% to 75% of your replacement needs with this Kit!*

### CAN I AFFORD IT?

No serviceman who uses controls frequently can afford to be without it. You pay only the standard net price of the controls, switches and shafts. The All-Metal Cabinet (worth \$2.50) is included free.

### DOES IT CONTAIN THE CONTROLS I NEED?

The carefully selected control assortment is based on a nation-wide survey of servicemen's needs. It includes only popular controls, widely universal in application, thanks to the Tap-in Shafts. If you find by experience, however, that, due to some local predominance of certain sets, you would prefer any other IRC Type D Universal Controls, your jobber will gladly make the exchange *at any time.*

### HOW WILL I KNOW WHAT CONTROLS TO USE?

Included free with your Cabinet is the latest IRC Volume Control Guide. This indicates exactly what controls to use for practically all sets you may be called upon to repair.

### WHAT ABOUT OBSOLESCENCE?

The only things that *could* become obsolete are the shafts and, as fast as new shaft styles are required, IRC will have them—of Tap-in design and constructed for use with the Type D Controls contained in your cabinet.

### ARE "MIDGET" CONTROLS ANY GOOD?

Don't call IRC Type D Universal Controls "Midgets"! Actually, they are small-size replicas of the larger IRC Type CS Controls—the only small controls that are exact mechanical reproductions of a manufacturer's larger controls. You can use them satisfactorily wherever Type CS or old-style larger controls have been used in the past.



### WHAT ABOUT TAP-IN SHAFTS?

IRC Tap-in Shafts make controls easier to install in a crowded chassis by obviating the necessity for removing other parts. They won't pull or vibrate loose. A variety of special shafts enables you to make the 18 Controls handle an amazing variety of jobs, standard and special.

### WHY HURRY?

Well, why postpone getting your Cabinet and starting to collect dividends on a good-paying investment? And don't forget the re-allocation of broadcast station wave lengths! Countless customers will want you to re-adjust their push-button tuning. Carry your IRC Control Cabinet on these jobs. You'll be surprised how many control replacement jobs you can also sell—and do the work right then and there!

### WHAT'S THE BAD NEWS?

There is none! Your total investment is only \$14.97 net (List, \$24.95). This equips you for the big majority of control replacements—and you get the \$2.50 Cabinet free. Many IRC jobbers are glad to extend easy terms and otherwise cooperate in making your IRC Control Kit actually pay for itself in the time, money and effort it saves during the first few months you own it!

*See it at your IRC jobber's today, or write to us for folder.*

INTERNATIONAL RESISTANCE COMPANY  
401 North Broad St., Philadelphia, Pa.

# TYPE D UNIVERSAL VOLUME CONTROLS

WITH TAP-IN SHAFTS

# SERVICE NOTES

## Nebraska Serviceman Loans Set During Repairs

L. H. Cook, owner of Cook Radio Service, 211 K St., Lincoln, Neb., endorses the idea of leaving a small set with the customer while the old set is being repaired. A satisfied customer is the best form of advertising says Mr. Cook, and the convenience of a loan set builds satisfaction.

Cook has been in the radio game since 1928, and holds the ham license W9FWW. A photo of his service bench shows the handy outlets for 110 AC and 6 volts DC. A soldering iron heat control is also built into the rear bench strip. Antenna terminals and small drawers add to the convenience. Note the inclined test equipment panels. Plenty of work space and knee room add to the bench features.

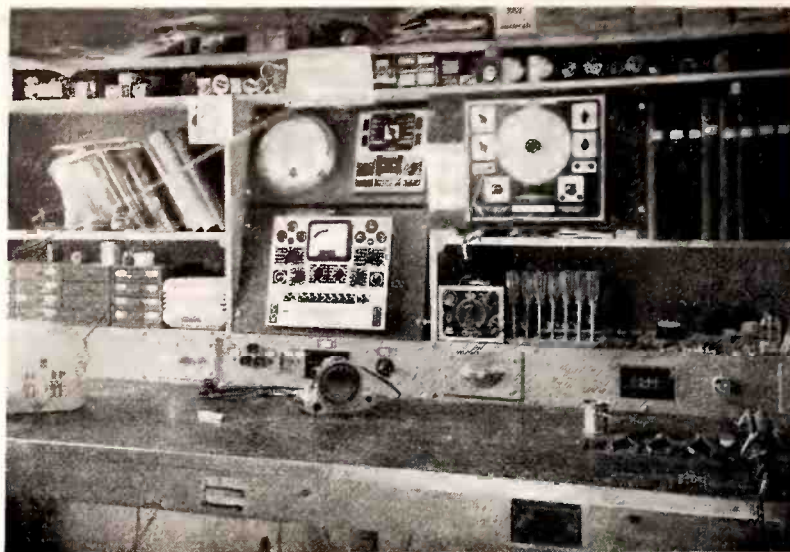

Convenient layout is the feature of the bench at Cook Radio Service, Lincoln, Neb. AC and DC power outlets are along the rear strip of the bench. Test equipment is Precision and Solar.

## Typical Troubles

### Acratone 9A

### Oscillation

Oscillation which is traced to the second RF circuit is easily remedied by turning the second RF coil at right angles to the antenna coil.

### Airline 190

### Intermittent

Rapid fading followed by a hum. Replace cathode condenser. Gradual cutting in and out is due to audio coupling condenser.

### Airline 290, 351, 455

### Slow fading

If set plays normally and then fades out, replace the 6A8G even though tester shows it to be ok.

### Airline 729A (Belmont)

### Dead

If set is dead but tubes and voltages test ok, move the brown lead from green lead on speaker terminal board to the black lead.

### Airline 512A

### Low volume

Tubes and voltages ok. Check for speaker shorting out. Usually occurs on new model after being in operation a short time.

### Airline 62-190

### Intermittent

Replace .01 coupling condenser from 6B7 to 6F6 grid.

### Emerson 336

### Distortion

Voltage measurements at 50L6GT socket show 50 volts on plate, 10 volts positive on control grid. Replace shorted or leaky grid coupling condenser.

### General Electric M5

### Fading

A fading condition in this set which is hard to find is often caused by the coupling condenser from the plate of the 6B7 to the grid of the 42 opening up. Replace with a .01 mfd 600-volt unit.

### Grunow (1937 Models)

### Hum

A peculiar hum which develops on some of the Grunow 15 tube models after the set has played for a few minutes can be eliminated by connecting the shell of the large speaker to ground.

### Kennedy 62D

### Intermittent

When the tuning meter is jumpy, accompanied by erratic action of the set, the trouble may often be traced to intermittent opening of the 4200 ohm section of the candohm voltage divider. This will check OK with the switch off.

### Philco 37-600

### Dead

Oscillator coil open.

### RCA K80

### Intermittent oscillation

Replace 6SA7 screen to ground by-pass with 0.25 mfd. for increased "pep."

### Westinghouse WR-480

### Dead

Set takes 150 watts instead of normal 55. Input filter condenser shorted. Replace with 8mfd., 450 volts.

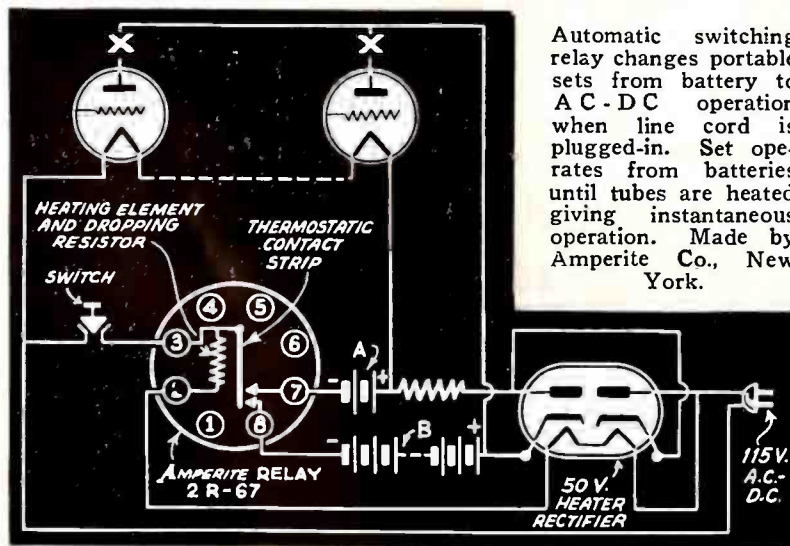

Automatic switching relay changes portable sets from battery to A C - D C operation when line cord is plugged-in. Set operates from batteries until tubes are heated giving instantaneous operation. Made by Amperite Co., New York.

## Radio at Ultra-High Frequencies

### RCA Institutes Technical Press

This 456 page book is an assemblage of technical papers from engineers of the RCA Laboratories relating to transmission, propagation, relaying, measuring, and receiving of radio signals above 30 mc. The field of high frequency radio includes the subjects of television, frequency modulation, and magnetron oscillators at 300 to 600 mc. Considerable space is devoted to the subject of television antennas and the propagation of these signals over various paths. The book is well illustrated with diagrams and charts.

In television, the results of horizontal and vertical polarization of the signal are charted for the NBC station, W2XBS for the New York City area. This book is offered free with third year subscription to *RCA Review*.

LET THIS **Fidelitone** SALESMAN *work for you!*

*Nationally Advertised* **50¢**  
**Fidelitone**  
 FLOATING POINT  
 6 MONTHS SERVICE FROM EACH NEEDLE  
 PHONOGRAPH NEEDLE

FILTERS RECORD SCRATCH THROUGH FLOATING POINT

Put this FIDELITONE Floating Point Counter Salesman to work for you NOW! . . . Increase your phonograph needle profits with FIDELITONE Floating Point Needles . . . Order a display today from your distributor or write the makers.

**PERMO PRODUCTS CORP.**  
 Manufacturing Metallurgists  
 6415 RAVENSWOOD AVENUE, CHICAGO, U. S. A.

PERMO POINT

**New!**  
 COVERS ALL PHASES OF  
**VTVM**  
 IT'S A Rider BOOK

**OUT MARCH 1ST  
 ORDER NOW**

150 pages—profusely illustrated—hard cloth covers  
**\$1.50**

**CHAPTER HEADS**

1. Fundamentals of V-T Voltmeters
2. Diode VTVM
3. Triode VTVM
4. Slide-Back VTVM
5. Tuned VTVM
6. A-F and Logarithmic VTVM
7. Electronic (D-C) Voltmeters, Microammeters, Ohmmeters
8. Calibration, Testing
9. Design, Construction
10. Applications of VTVM
11. Commercial Types

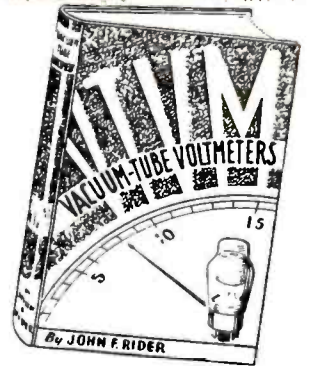

**T**HE increasing use of vacuum-tube voltmeters in the servicing field has created a demand for a book that thoroughly explains the subject from the serviceman's viewpoint. The new Rider Book, "Vacuum-Tube Voltmeters", presents the practical aspects as well as explaining the principles underlying the functioning of various classifications of v-t voltmeters.

This book is chock full of information—on theory and practical data—such as one serviceman would tell another. You need "VTVM" if you are to get the most out of your present v-t voltmeter—or if you are to buy the one best suited to your needs—or if you are planning to build one of your own. A big \$1.50 value. Order your copy today!

**Every Successful Service Shop Has  
 A COMPLETE SET OF RIDER MANUALS**



Volumes XI to VII, covering 1940 to 1936, \$10.00 each.  
 Volumes VI to I, covering 1936 to 1920, \$7.50 each.

**JOHN F. RIDER, PUBLISHER, Inc.**  
 404 FOURTH AVENUE, NEW YORK CITY  
 Export Division Roche-International Elec. Corp., 100 Varick St., N. Y. C. Cable: ARLAB

*Coming!*

1941-42  
**RADIO YEAR BOOK  
 & TRADE DIRECTORY**

**RADIO'S BIGGEST  
 SELLING DRIVE**

*Coincident with the great  
 frequency shift, March 29*

*Both featured in the*

MARCH ISSUE OF



## Zenith Shows 14 New Prosperity Models

The appearance of a new line of 14 "Prosperity" radios has been announced to distributors and dealers by Zenith Radio Corp., 6001 Dickens Ave., Chicago. The new sets, which range from a table model plastic for \$11.95 to a 10-tube automatic record changing combination for \$169.95, are brought out at this time to help radio dealers get their share of the new buying power which results from the National Defense Program. Representative units are pictured in the "New Products" section of RADIO TODAY.

In the Prosperity Line are—seven table models, two models for 1½ volt battery pack or 110 Volt AC-DC operation, a portable Poketradio, a "strategically priced" console, two automatic record changing combinations, and a special AM-FM console.

Notable among the new jobs, according to Edgar G. Herrmann, acting sales manager, is model 10-S-567—a ten tube console offering Push-Pull, 14 watts output, Rotor Wavemagnet, Radiorgan, 3 gang condenser, automatic tuning, 14 inch speaker, guaranteed short wave reception, etc.

Another featured model is the 5-D-610, with a factory list price of \$11.95, representing a new all time low in Zenith pricing.

Zenith will continue its slogan, "Only Zenith Has This" in advertising, with particular reference to the 64-position Radiorgan tone color blender found on most Zenith sets sell-

## Dealer Cops Car Prize



Retailer H. Sylvester, Brooklyn, N. Y., won this 1941 Pontiac in RCA Victor tube promotion, staged by Bruno-New York, Inc., distributor.

ing for \$39.95 or over, and the patented built-in movable Wavemagnet used on the Universal Portable. Mr. Herrmann has described the latter as the "Radio That Knows No Season."

The addition of model 10-H-573 brings the total of Zenith FM models to three,—one a chairside, one a spinet design, and one in a conventional console. Zenith says that "with more and more FM broadcasts going on the air the selling momentum of FM radios is enjoying a sharp upward trend." To further FM interest the firm has maintained an experimental broadcast sta-

tion in Chicago for over a year, offering continuous musical entertainment of the "dinner music variety" from 7:30 each morning till Midnight.

## California Radio Dealers Go to Pasadena

Radio dealers and salesmen, more than 125 of them in San Francisco and the bay region, were given an all-expense trip to the Tournament of Roses and Rose Bowl Game in Pasadena, a gala New Year's celebration on the train, and the company of such celebrities as Irene Rich and Rudy Vallee, at the end of the Rose Bowl Jamboree sponsored by General Electric.

The Jamboree radio sales drive was planned by Ted Hall GE radio man on the coast, along with the GE Supply Corp., San Francisco; C. W. Goodwin, district manager; George Lloyd, appliance sales manager; and Walter Boland, radio sales manager.

## Sylvania Plant Officials Get Promotions

News from the tube division of the Hygrade Sylvania Corp., is that M. D. Burns has been appointed factory manager of the Sylvania tube plant at Emporium, Pa., H. W. Zimmer, general manufacturing manager of the division, made the announcement. C. R. Razey, formerly the general foreman, now takes the post of factory superintendent vacated by Mr. Burns.

At the Salem, Mass., plant of the Sylvania firm, factory manager J. J. Jackman has announced that C. A. Haines has been named factory superintendent there.

## Goat Company Changes Name

The name of Goat Radio Tube Parts, Inc., 314 Dean St., Brooklyn, N. Y., has been changed to Goat Metal Stampings, Inc., in order to more accurately reflect the nature of the products now made by the firm. The company makes the tube parts and shields used by many of the leading radio set makers, but has expanded its plant and operations to include work on other metal stampings. Officers, personnel and policies of the Goat organization remain the same.

## Eicor Moves to Bigger Plant

Eicor, makers of Dynamotors, power plants, converters, etc., now enjoy greatly expanded manufacturing facilities at a new plant at 1060 W. Adams St., Chicago. New and modern equipment is being used for the Dynamotors, which are widely used with amateur, aircraft, police and marine radio equipment. Eicor power plants come in four general sizes, to supply current for farms, boats, sound trucks, etc., where radios, lights or appliances are used.

# VELOCITY AMPERITE P.G. DYNAMIC

## 2 GREAT MIKES!



**AMPERITE VELOCITY**  
with exclusive  
**ACOUSTIC COMPENSATOR**

Actually a combination Velocity-Dynamic, having best features of both types.

Model RBHk, hi-imp: (RBMk, 200 ohms); LIST \$42.00  
Model RBSHk, hi-imp: (RBSk, 200 ohms); LIST \$32.00



**ELIPSOID PICKUP PATTERN**

Features new superior **UNI-DIRECTIONAL** elipsoid pickup pattern.

**ELIMINATES FEEDBACK TROUBLE. HAS FLAT RESPONSE.**

Model PGH, hi-imp: (PGL, 200 ohms); 40-10,000 CPS,..... Chrome LIST \$32.00  
Model PGAH, hi-imp: (PGAL, 200 ohms); 70-8000 CPS,..... Chrome LIST \$25.00

### AMPERITE KONTAK MIKE

Puts musical instruments across. Beautiful results with any amplifier, record player, and most radio sets.

MODEL SKH (hi-imp).....LIST \$12.00  
MODEL KKH, with hand volume control, LIST \$18.00  
Plug extra.....LIST \$1.50



**AMPERITE** WRITE FOR FREE SALES AIDS  
561 BROADWAY  
NEW YORK



## Southern Dealer Builds a Customer-Getting Display



The newest radios are deftly lined up near the entrance at Bon Marche Store, Asheville, N. C. Emerson distributor in that area, Brown-Rogers-Dixson Co., reports that "it proved itself extremely successful in promoting sales."

## Victor to Open School for Record Dealers

A new series of "schools" for record dealers have been announced by RCA Victor record sales manager W. W. Early. They will be held by the Victor distributor salesmen in each area of the country, and offer to retailers all possible information and training on how to sell more records and to make more profits. Subjects in the course include merchandising, market analysis, inventory control, advertising and promotion, etc.

The schools are built around the new "Victor Record Merchandising Institute Manual," a 125-page handbook dealing with every problem of the record dealer.

## Manufacturers Rep Offers Services

An announcement has been received by RADIO TODAY, to the effect that the sales manager of a nationally known electrical manufacturer will enter the manufacturers representative field April 1st. This executive emphasizes his command of technical subjects and his wide acquaintance from New York to Washington. He will offer manufacturers of quality apparatus complete jobber and industrial sales engineering coverage. Interested parties should contact RADIO TODAY, Box 720, 480 Lexington Ave., New York City.

## Webster Electric Adds Factory Facilities

Webster Electric Co. of Racine, Wisconsin, has announced a new addition to its plant. The expansion will hike the manufacturing floor area about 30 per cent and will be of the most modern type of construction.

Business being done by Webster Electric in all of its lines, particularly in the sales on Teletalk, pick-ups, and sound equipment, has increased so that this expansion program becomes necessary.

## "TSK! TSK!" SAID ADAM HONEYMUG, "THE WAY THEY FUSS ABOUT CONDENSERS!"

Serviceman Adam Honeymug brushed a cobweb from beneath his chin, propped his feet more securely on the service bench and leaned back comfortably in his chair. "These parts manufacturers are screwy," he said to his wife. "Take the time I was up in North Adams, Mass., and dropped into the Sprague factory. The way those fellows fuss around, you'd think condensers were the most important part of a radio set."

"Yes, dear," replied his wife patiently. "That reminds me. While you were over at the taproom, Mr. Jones called and said that condenser you put in his radio set had exploded. It scared the canary so it won't sing any more. He said if you didn't put in a good condenser this time, he'd come over here and kick your teeth in."

"What's he griping about, anyway? Just because I picked up that condenser for 16c and it doesn't have any name on, he thinks it's no good. He's screwy, too."

"Yes, dear."  
"Well, as I was saying, kid, you'd a died laughing up in North Adams. Just think of it! They've got about twenty engineers, doing nothin' but designing condensers. I could do it with my eyes shut."  
"I always said you were wonderful, darling."

"I could certainly show those birds how to reduce the cost of condensers. Why, when they make wet electrolytics, do you think they'd take faucet water? It's good enough for 'em to drink—but it ain't good enough to put in their condensers. They built a special dam up in the mountains and piped spring water into the plant. They even distill that. They're screwy. I could . . . say, answer that 'phone, will ya."  
"It was the telephone company," ex-

## "Know Your Stuff" Meetings Go West

A new series of RCA's "Know Your Stuff" meetings for parts jobbers and their sales organization are being held in Cincinnati, St. Louis, and Kansas City, according to L. W. Teegarden, manager of the RCA tube and equipment division. Meetings have already been held in New York, Philadelphia, Boston, Cleveland, Detroit and Chicago.

Mr. Teegarden heads a delegation from Camden headquarters to hold the meetings. Others are L. A. Goodwin, Jr., test equipment and accessories sales manager; D. Y. Smith, power tube sales manager; J. P. Allen, tube and equipment advertising manager; and W. H. Allen, manager of tube and equipment distribution. John F. Rider is scheduled to discuss new trends in the service field.

## Banquet in the Lehigh Valley

The Lehigh Valley Radio Service Association held their 3rd annual banquet late last month at the Hotel Allen, Allentown, Pa. Servicemen brought their friends to this big event which included, besides the dinner, prizes, favors, speakers, floor show, and displays of test equipment by local jobbers.

plained his wife a minute later. "They said they are cutting off our service until we pay our bill."

"To heck with them," exclaimed Adam. "I don't need a 'phone much anyway. Well, as I was sayin', those guys up at Sprague spent about 'steen thousand dollars developin' special machines to put the electrolytic formation on the aluminum foil used in dry electrolytics—just to make sure that every tiny bit of area was covered with the electrolyte. If they'd asked me, I'd a told 'em to paint it on with a brush."

"But maybe that wouldn't be so good, dear."

"Lissen, kid. I know what I'm talking about. Why, take the way they test condensers. They got about a billion good-lookin' girls doin' nothing but testing. They test the condensers

for everything—capacity, working voltage, surge voltage, leakage and series resistance and goodness knows what else. Think what that costs."

"Yes, dear."  
"Yea, but that ain't the worst of it. They even throw the bad ones away. I offered to buy some for half price, but they said they wouldn't let me have 'em at ten times the regular price. They'd rather bust 'em up for junk than get real money for them. If that ain't screwy. Hey—what the . . ."

"Oh, darling, the shop is on fire. Call the fire department, quick!"

"Huh, and give those screwy dopes down at the engine house a chance to wreck my business? Nothing doing. Let it burn. I don't much like this radio service racket anyhow."

**SPRAGUE PRODUCTS COMPANY**  
North Adams, Mass.



# RECORDS AND RECORDERS

## FINE POINTS IN RECORD PROFITS

(Continued from page 37)

needles in succession, for comparison.

When making comparative tests of needles, dealers should remember to take into consideration not only their own musical ear, but also that of the customer, which is most important in the final analysis.

There should be also a display style in the store that will regularly emphasize quality needles. Display stunts may include diagrams of points and grooves, displays of pickups from manufacturers, illustrations of distorted music, etc.

## PROFIT SCHEDULE

Finally, it is important to have an aggressive attitude toward "selling up" in needles. Don't be afraid to move up to more expensive needles or the quality pickups. Plenty of prospects want the convenience of 15,000 playings without a needle change and are willing to pay for it. The trend to automatic record changers helps this market because these changers are not really practical if the operator has to keep interrupting it to change the needle.

For the market between the cheapest needles and the most expensive sapphire ones, there are now available the needles whose average service is rated

in months. These retail at medium prices, well within reach of masses of record fans.

An additional sales point: when you are trying to sell a quality needle, and have on your floor an expensive combination which comes equipped with it, be sure to point out that the needle is the choice of leading manufacturers. It will help.

It is reported that in Dayton, Ohio, one aggressive radio dealer is offering permanent jewel needles with his combinations, and bringing the customers in! He's using large newspaper space to plug the deal, and he's making plenty of sales. This action illustrates how new needles can be used as a fresh way to attract buyers.

## Hammermill Paper Goes in for Discs

New entry into the business of manufacturing blank discs for home recording is the Hammermill Paper Co., Plastics Division, Erie, Pa. A complete line of blanks will be sold through jobbers and dealers; the Hammermill disc comes in 6", 8", and 10" sizes, complete with dealer displays.

## Walco Has Lower Price on Sapphires

A price reduction of 30 per cent on Walco sapphire phonograph needles has been announced by Electrovox Co., 424 Madison Avenue, New York City. The list price for the jewel needles is now \$1, with full trade discounts applying. Electrovox says that the new price is made possible by "a vast production increase brought about by adoption of Walco needles as standard equipment on new phonographs of leading manufacturers."

Walco execs point out that the widespread interest in light-weight pickups with permanent jewel points has made the 1941 sales theme, "No More Needles to Change." The idea is being vigorously promoted by leading makers of new combinations and Walco sees "a tremendous sales in-

## Good Sales Bets Among New Discs

WILL BRADLEY and his orchestra playing 3 Ring Ragout—Columbia 35871.

BING CROSBY, with John Scott Trotter and orchestra, singing A Nightingale Sang in Berkeley Square—Decca 3584.

SAMMY KAYE playing Until Tomorrow, with VR by The Three Kadets—Victor 27262.

GLENN MILLER and his orchestra playing Frenesi—Bluebird B10994.

TOMMY TUCKER playing Big and Fat and Forty-Four with VC by Kerwin Somerville—Okeh 5949.

CHARLIE BARNET and his orchestra playing Scrub Me Mama With a Boogie Beat with VR by Ford Leary—Bluebird B10975.

BENNY GOODMAN and his orchestra playing I Hear a Rhapsody with VC by Helen Forrest—Columbia 35937.

ELLA FITZGERALD and her orchestra playing Hello Ma! I Done It Again! from the 20th Century Fox Picture, "Tall, Dark and Handsome," with VC by Miss Fitzgerald—Decca 3612.

crease" for dealers and jobbers who handle the sapphires.

Along with the new low price, Electrovox offers the jewel points in a new plastic package, and a counter-card dispenser with 12 packs on it. Literature ties up with continuous national advertising.

## Victor Lines Up New Symphonies

In recent Weeks RCA Victor has signed up no less than six leading new symphony orchestras, two smaller symphony groups and several new artists and specialty units. These include the National Symphony Orchestra of Washington, D. C., under the direction of Hans Kindler; the Indianapolis Symphony Orchestra, led by Fabien Sevitzky; the Cincinnati Symphony Orchestra, directed by Eugene Goossens; the San Francisco Symphony Orchestra, led by Pierre Monteux; the Toronto Symphony under Sir Ernest MacMillan; the Graduate Orchestra of the National Orchestra Association; and the



**SPECIAL RECORDINGS**  
Hymns, Sacred Songs Attract Church Patronage

SELECTED sacred and semi-sacred compositions—the favorites of millions. Meet the present amazing demand for selections of a serious type. Reproduced in acetate low-scratch materials. Advertised in an influential list of religious publications.

Prospective customers for these records know what they want, and only perfected renditions are necessary to sell them. It is also a fact that such renditions of sacred songs, hymns, suitable for all denominations, are extremely rare. Equip yourself to meet this situation. You can—with profit.

A number of these records are made especially for musical towers or carillons—no scratch, two-sided acetate 12" transcriptions. All suitable for both Catholic and Protestant churches, religious organizations, lodges, etc.

Write for list.

**SUNDT ENGINEERING CO.**  
4763 RAVENSWOOD AVE. CHICAGO, ILL.

SUNDT ENGINEERING CO.  
4763 Ravenswood Ave.  
Chicago, Ill.

Please send list of records, and further information on music for carillons, etc.

Name .....  
Company .....  
Address .....  
City ..... State .....

## GI-C120 Simplified Record Changers are Profitable . . .



Model GI-C120 drop-type changer. Unit includes changer—turntable—sturdy, powerful direct-drive motor—cycling and on-off switches—high-quality tangent-tracking crystal pickup.

**The GENERAL INDUSTRIES CO.,** DEPT. 15, ELYRIA, OHIO  
Order Your Cutting and Play-back Needles from our affiliate, General Phonograph Mfg. Co., Inc., Putnam, Conn

Everybody likes the new, simplified, easy-to-operate GI-C120 Record Changer. A seller! Customers like its ONE-LEVER adjustment to set for either 10" or 12" records and for hand changing. Streamlined, smart looking in all cabinets. Built for convenience coupled with highly satisfactory playing. Made by the world's largest phonograph motor manufacturer. A good volume profit builder. Order one to test in your own way. Please state voltage and frequency of current you use.

## Display for Howard Discs



With an attractive display for dealers and jobbers, Howard Radio Co., 1731 Belmont, Chicago, calls attention to its "Type C" recording discs. These blanks come in 6½", 8" and 10" sizes, have a soft steel base with special Howard lacquer coating. The qualities emphasized are "practically no tearing," low surface noise, and longer life.

Howard has also announced a new low-cost, long-life recording needle, and two new play-back needles.

Philadelphia Chamber String Simphonietta, under the direction of Fabien Sevitzyk.

New artists include: Eleanor Steber, young American lyric soprano who recently made her Metropolitan Opera debut; Norman Cordon, Metropolitan basso, and Leonard Warren, baritone also of the Metropolitan. Rose Bampton has signed a new contract as a soprano.

Besides its new orchestral additions, the Victor Red Seal label now offers music by 48 different orchestras, including the Philadelphia Orchestra under Stokowski and Ormandy; the NBC Symphony under Toscanini; the New York Philharmonic under Mengelberg, Toscanini, Beecham and Barbirolli; the Boston Symphony under Koussevitzky, etc.

## Columbia Signs New Singing Star

Rise Stevens, the brilliant young American mezzo-soprano of the Metropolitan Opera, has signed with Columbia Recording Corp., to make records exclusively for Columbia Masterworks. Miss Stevens has been engaged by MGM to appear in "The Chocolate Soldier" with Nelson Eddy.

The newest addition to the Columbia Masterworks roster, Miss Stevens joins a long list of artists and orchestras now recording exclusively for CRC, which includes Nelson Eddy, Suzanne Sten, Bruna Castagna, Josephine Antoine, Charles Kullman, John Barbirolli and the New York Philharmonic-Symphony Orchestra, Artur Rodzinski and the Cleveland Orchestra, Leopold Stokowski conducting the all-American Youth Or-

chestra, Dimitri Mitropoulos and the Minneapolis Symphony, Joseph Szigetl, Nathan Milstein, Bela Bartok and Edward Kilenly.

## Bargain Package from Recoton

A new tin box of 200 Automatic phonograph needles has been announced by Recoton Corp., New York City. These needles, which appeared about a year ago are regularly packaged in envelopes of 30, selling at 25c. The new box contains 200 and sells for \$1.25.

Recoton says that the Automatic point "has the qualities of the regular Recoton "Superior" needle—low

surface noise, fine reproduction and low record wear—besides the special feature of being unbreakable." The latter quality is of extra importance when used with record changers.

This company reports that its shipments of needles from Switzerland are now coming through with great regularity providing ample supplies for the fast-increasing demand. Recoton has recently moved its offices from 178 Prince St. to 42 W. 15th St.

## Masco Expands

New factory and showrooms for the Mark Simpson Mfg. Co., Inc., makers of Masco sound systems and accessories, have been opened at 186-194 W. 4th St., New York City.

**YOU'VE GOT A SURE SALE WHEN YOU SHOW THEM THE NEW PRESTO, JR. TURNTABLE**



● Radically different in design and performance from any other turntable on the market . . . excellent for playing sound effects, phonograph records or 16" electrical transcriptions. A 12" dual-speed table that matches closely the performance of a 16" table at *one-fourth the cost*. It's precision-machined, dynamically balanced, hand-finished throughout . . . powerful, vibrationless. Speed is accurate to .4%, regulation within a revolution .2%. Show it to your customers who want a *better* turntable. Write for catalog sheet and price.

Canadian Distributor: Walter P. Downs, 2313 St. Catherine St. W., Montreal, P. Q.

**PRESTO RECORDING CORPORATION**  
242 West 55th Street, New York, N. Y.

World's Largest Manufacturers of Instantaneous Sound Recording Equipment and Discs

**FOUND: \$348 LOST SENDING TELEGRAMS!**

Last year a certain firm (name on request) saved \$348 on telegrams by having Postal Telegraph survey telegraph costs! Let this free telegraph cost analysis work for you. It uncovers huge waste, and provides easy-to-follow plan to stop it!

**WIRE COLLECT:**

For information about free telegraph cost analysis—wire collect: J. J. O'Donnell, Postal Telegraph, 253 Broadway, N. Y. C. No obligation!

**Postal Telegraph**



# SALES HELPS



Colorful new display in washable wallpaper. See Col. 3.

## Admiral Ready With Pair of Sellers

A pair of new and striking displays have been released by Continental Radio & Television Corp., 3800 Cortland St., Chicago, for Admiral sets. The first is the D66 display board, for the new automatic record changers and any four of the Admiral Bakelite jobs. D66 comes in washable wallpaper, with two pin-up lamps included. It's 6 ft. by 8 ft., but side panels bend to various angles.

Admiral has also issued a 6-color counter display card for the 2R-G5 Bantam 3-way portable.

## Bamberger Exec Expands Radio & Records

News from L. Bamberger & Co., Newark, N. J. is that W. Karl Trukenbrod, manager of the camera, radio and record departments, will now concentrate exclusively on radio and records. The increasing importance of new radio products, such as FM and television, and the fast-growing volume of record sales, are given as the reasons for the move.

## Radio Salesgirl



One of Crosleys glamour cards, matching the figure in the national advertising.

## New Victor Record Books Ready

The new, longer and improved 1941 Victor Record catalog is out, presenting for the first time Victor's "vast recorded library" at the new list prices. Special features include a complete glossary and pronunciation guide, a complete chronological list of composers, "The Music America Loves Best," complete list of Bluebird children's records, instructions on how to use the catalog and find new records, list of educational records and school aids, and a listing of record accessories and storage albums. It sells at 15c.

Also announced are the new Bluebird Popular and Bluebird Old Familiar and Race Catalogs, both with handsome covers identical in size.

## Dreyfuss to Eagle

Jules J. Dreyfuss who has been in the electrical industry over 30 years is now with the Eagle Electric Mfg. Co., Inc., as director of sales. Mr. Dreyfuss until recently was sales manager of the Marks Products Corp.

## Stromberg's Leader



Just one of Stromberg Carlson's new series of store displays, a life-size, 6-color background piece. SC also has 4 gold-and-black eased cards.

## Announcing the improved 1941 RECORD BAR\*

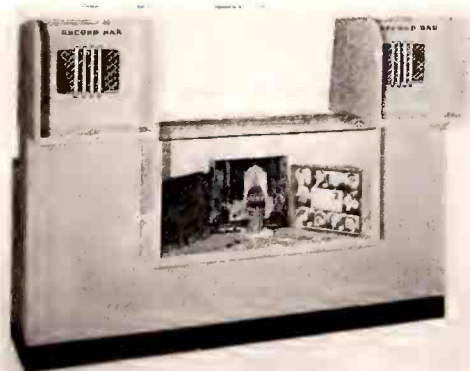

The new high fidelity unit is fully equipped for finer reproduction through the use of the latest type of high fidelity amplifier, feather-weight pickup and sapphire needle.

Features of the new Bitter Record Bar give added merchandising power to this sensational unit, in which all stock keeping, selling and demonstrating activities are centered in one compact, inexpensive fixture—giving utmost economy in equipment and floor space.

Send for Free Folder

**A. BITTER CONSTRUCTION CORP.**

2701 Bridge Plaza North

Long Island City, N. Y.

\*Reg. and copyrighted U.S. Patent Office 1940.

Record Rack No. 100 may be used separately or as a unit of a large record dept. Capacity 500 10" records, 500 12" records and 75 albums. Price \$44.00 F.O.B. Factory

Established 1920



## Smart Cabinet Shown



Here's one of Admiral's two new record cabinets, specially priced when paired with the firm's new table model combos.

## Radio Log Helps California Dealers

Radio dealers in California are enjoying a great deal of extra store traffic as a result of a "Radio Log" sales help issued by the Bureau of Radio & Electric Appliances of San Diego. The log, in its newest edition, is a 2-color, 8-page, booklet titled "The Greatest Show on Earth." Over 20,000 copies have been picked up by interested radio fans, during the first month following its appearance. The report is that "dealers unanimously agree that the log has increased sales volume, particularly on the higher priced sets."

The booklet lists regularly scheduled network programs, over popular local stations—giving time, station, and name of program for each day of the week. A separate tabulation lists news broadcasts for each day. The log also includes a page giving dial setting, location, network affiliation and power of all broadcast stations regularly heard in the area. Short-wave stations in the United States and foreign countries with call letters, location, broadcasting time and dial

setting also appear on this page. Consoles, radio-phonograph combinations, portable sets and records get attention on the inside front cover, while the back cover has a selling message on the home recording feature.

## Hall to Direct Masterworks Promotions

A newcomer to the sales promotion department of Columbia Recording Corp. is David Hall, who according to the announcement by CRC promotion director Patrick Nolan, will now handle Columbia Masterworks promotion. Mr. Hall is the author of "The Record Book," and was formerly book and music reviewer for *Saturday Review of Literature*.

## "Ken" Foute Joins Drake Mfg. Co.

At the Drake Mfg. Co., 1713 W. Hubbard St., Chicago, it has been announced by the company head, A. J. Foute, that his son, Kenneth Foute, has joined the firm as sales engineer. The new appointee is specially trained in engineering and modern business practices. The Drake company manufactures Dial and Jewel pilot light assemblies.

## Pennsylvania Saleswoman Wins Havana Trip

Miss Gertrude Enck of the J. H. Troup Music House, Harrisburg, Pa., has been named winner of RCA Victor's "War Horse Sweepstakes" contest for record dealers.

She will get an all-expense tour of Havana for two, for her 100-word statement summarizing record sales activities.

## Siegel a New Exec at Electromatic

Robert Siegel, who has been in radio for a total of 15 years and previously worked with Fada Radio, is now the vice-president in charge of sales, for Electromatic Distributors, Inc., 88

University Place, New York City. Electromatic is the maker of Weston radio sets.

## Speaker Manufacturer Wants a Rep

A manufacturer has communicated with RADIO TODAY to the effect that "we want a manufacturers representative to handle complete line of speakers to manufacturers in Indiana, Ohio and Michigan. We have no representation at present."

Any rep interested in this announcement should write to Box 16, RADIO TODAY, 480 Lexington Ave., New York City.



It seems that Homer G. Snoopshaw, B.R.S., (Battery Replacement Specialist), hasn't been strictly on the up-and-up in his capacity as Vice-President-In-Charge-of-Replacements. As we understand it, one of the helpers, jealous of Homer's rapid rise in the personnel of Bud's Radio Shop, did a little snooping on the snoopster, and found that Homer had a copy of the Burgess Replacement Guide\* up his sleeve. The candid camera shot shown above is evidence that Homer can't explain—and *is his boss burned up?* We suspect that Homer will soon be "at liberty" again.

Does anybody in the audience need a Replacement Adviser\*?

**\*IT'S FREE**  
See Your Burgess  
Distributor or write  
Burgess Battery  
Company  
Freeport, Illinois

**BURGESS**  
*The Complete Replacement Line*

# HOWARD 718-APC - A Sales Getter in any Market... With Full Profits For You!

HOWARD'S reputation for top quality and progressive design is fully expressed in this powerful 12 tube, 3 band automatic phono-radio combination. 10 watts of push-pull audio with bass boost amplification achieves glorious reproduction. Has tuned R.F. amplifier, two I.F. stages and "fly-wheel" push button tuning. Beautiful massive walnut cabinet, trimmed with Brazilian Rosewood, is hand

rubbed to a piano finish. Economy of controlled manufacturing in the famous HOWARD plant is responsible for this spectacular and unsurpassed value.

Every model in the complete HOWARD line is a consistent profit producer. If you're looking for increased sales and larger profits, write today for the complete facts!

12 Tubes . . . . Record Changer . . . . R.F. Stage . . . . 12" Speaker . . . . Push-Pull Output

**HOWARD RADIO COMPANY**

1731-35 Belmont Av., Chicago, Ill. - Cable Address: HOWARDCO, USA

*America's Oldest Radio Manufacturer*

# NEW JOBBERS & REPS

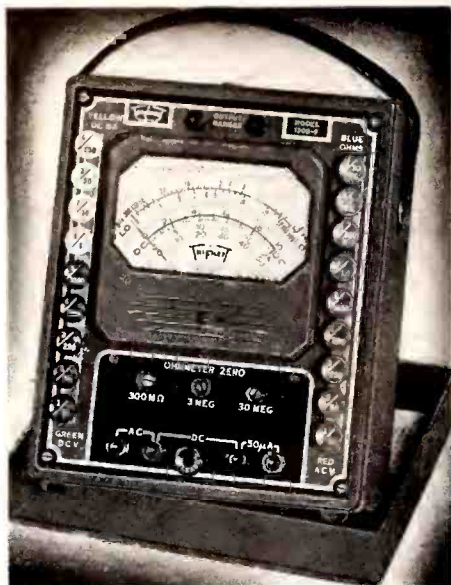

Dealer Net Price

**\$27.84**

Model 1200-F  
Push-Button Type

Push-button switching by a new, simpler way makes the Model 1200-F an entirely automatic Volt-Ohm-Milliammeter with maximum speed and minimum switching. Only one button need be pressed for any range and test setting. Ranges: DC, 0-10-50-250-500-1000 at 25,000 ohms per volt . . . AC, 0-10-50-250-500-1000 at 1000 ohms per volt . . . DC Milliampers, 0-1-10-50-250 . . . DC Microampers, 0-50 . . . Resistance, 0-1000. Low ohms, shunt type circuit; 0-300,000 ohms; 0-3 and 0-30 megohms, series type circuit. Self-contained batteries for all ranges. RED•DOT Lifetime Guaranteed Instrument, rectifier type. Attractive metal case with rich brown suede enamel finish. Panel with new three-tone finish. Dealer Net Price . . . . .**\$27.84**

Model 1200-A—Selector switch operated . . . 2000 Ohms per Volt DC . . . Volt-Ohm-Milliammeter . . . Dealer Net Price **\$21.84**

Model 1200-C—Selector Switch Operated . . . 5000 Ohms per Volt DC . . . Volt-Ohm-Milliammeter . . . Dealer Net Price . . . . .**\$22.84**

Model 1200-E—Selector switch operated . . . 25,000 Ohms per Volt DC . . . Volt-Ohm-Milliammeter . . . Dealer Net Price . . . . .**\$25.84**

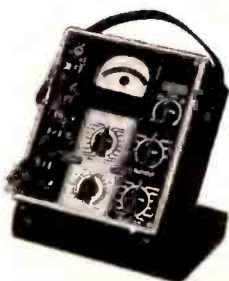

## MODEL 1213

Sockets to test all present day tubes including Bantam Jr., High voltage Series tubes including 117Z6G and 1.4-volt Miniatures. Ballast Tube Continuity Test . . . Foldex Tube Chart . . . RED•DOT Lifetime Guaranteed Instrument . . . Dealer Net Price . . . . .**\$22.00**

Write for Catalog—Section 192 Harmon Avenue

THE TRIPLET ELECTRICAL INSTRUMENT CO.  
Bluffton, Ohio

## Columbia in Boston



Back to Boston after 20 years as a key record executive, H. S. "Chick" Maraniss, right, is welcomed as the new jobber there by Columbia Record Corp. dist. manager, F. G. Cook. Mr. Maraniss will head Columbia Wholesalers Inc.

the state of California. . . . The Turner Co., Cedar Rapids, Iowa, makers of microphones and accessories, have named Herb Erickson, 14 Biltmore Ave., Asheville, N. C., as the Turner vibrator representative in Alabama, Florida, Georgia, North Carolina, South Carolina, and Tennessee.

TUBES—B. W. Glassman, 343 Manufacturers Exchange Bldg., Kansas City, Mo., has been announced by Raytheon Production Corp. as their new representative in the Missouri, Iowa and Nebraska territory. Mr. Glassman succeeds C. E. Moore, who resigned. . . .

COMMUNICATION RECEIVERS—Manufacturers rep Art Cerf has been appointed by Howard Radio Co., 1731 Belmont, Chicago, to take over their communication set line in upstate New York. . . .

RADIO SETS—Shadbott & Boyd, who have headquarters in Milwaukee, Wis., have been appointed distributors for Emerson to cover the Wisconsin and upper Michigan areas. Radio head of the Milwaukee firm is A. C. Schleiger, with William Holland as assistant; staff of 5 salesmen will shortly be increased to 7. . . . Admiral has named a trio of new distributors: A. S. Hatcher Co., Macon, Ga.; C. E. Hamlin Co., 225 N. Jackson, Jackson, Mich.; and Walding, Kinnan & Marvin Co., Toledo, Ohio.

RECORDS—New distributor for Columbia records in Boston and the New England areas is H. S. "Chick" Maraniss, according to word from Columbia Recording Corp. sales manager, Paul Southard. Mr. Maraniss, who has been with CRC since its organization and formerly served as assistant to Columbia president Edward Wallerstein, will head Columbia Wholesalers Inc. of New England, 584 Commonwealth Ave., Boston. . . .

SOUND EQUIPMENT—Jack Clawson, 117 Water St., Boston, Mass., is the new sales representative for Quam speakers in the New England territory, according to word from Quam Nichols Co. president James P. Quam. . . . B. L. MacPherson, 1919 Wells St., Ft. Wayne, Ind., was also named by Mr. Quam, as sales rep for Indiana and Kentucky.

APPLIANCES—Eight new jobbers have been appointed by general sales manager F. E. Bassler of Gibson Electric Refrigerator Corp., Greenville, Mich., to handle Gibson refrigerators and ranges—these are F. O. Carpenter & Son, Columbus, Ohio; I. Feldman Co., Providence, R. I.; Fargo Glass & Paint Co., Fargo, N. D.; Radio Accessories, Omaha, Neb.; Glasgow-Allison Co., Charlotte, N. C.; Graybar Electric Co., Atlanta, Ga.; McWilliams Hdwe. & Furniture Co., Longview, Tex.; and Otis Hidden Co., Louisville, Ky.

PARTS—Solar Mfg. Corp., Bayonne, N. J., makers of capacitors, have announced the appointment of Harry A. Lasure, 2216 W. Eleventh St., Los Angeles, Calif., as district manager for



# KEN-RAD

## DEPENDABLE RADIO TUBES



Unsolicited testimonial letters from users enthusiastically praising the performance of Ken-Rad Radio Tubes are constantly received. This proves conclusively their complete consumer acceptance. Write for the Ken-Rad selling plan.  
KEN-RAD TUBE & LAMP CORPORATION, OWENSBORO, KENTUCKY  
Export Dept., 116 Broad Street, New York, U.S.A. Cable Address: Minthorne, New York



The pay-off in the Shure Bros. contest—l. to r., Jim Faries, salesman; S. K. Macdonald, manufacturers rep; John Stern, Radio Elec. Service Co.; Gene Rothman and Morris Green. Story below.

## Pennsylvania Jobbers Score Touchdowns

Radio Electric Service Co., Philadelphia jobbers, have been named winners in the All-Star Football Game microphone contest, sponsored by Shure Bros., Chicago. Second place went to George D. Barbey Co., Reading, Pa.; both distributors were awarded loving cups and cash prizes. Both companies are in the area served by S. K. Macdonald, prominent manufacturer's representatives who is president of "The Representatives." Third prize was awarded to the Tydings Co., also a Pennsylvania jobber.

## Ideas for New Business

After returning a customer's radio, it's a good idea to leave business cards or circulars under the doors of several of the neighbors, writes John Pelensky, Philadelphia serviceman in *PRIMA News*. You might even use a card which explains that you just repaired Mr. S's radio—and that you feel sure he will be pleased to recommend you as a serviceman.

Keep your eyes on the want-ad col-

umns and offer to take on the service work (on a percentage basis) of companies who advertise for part-time servicemen or who advertise for a man at too low a salary.

## Wood to See Southern and Midwestern Dealers

Now calling on Ansley Dynaphone dealers in the South and Middle West is John J. Wood, sales manager for Ansley Radio Corp., 4377 Bronx Blvd., New York City. He's discussing with dealers the new Ansley promotion and sales plans and will be back to New York early in March.

## Mitchell Appoints Nickel Ad Manager

Mitchell Mfg. Co., Chicago, makers of lamps and fluorescent lighting fixtures, have named Edwin A. Nickel as advertising & sales promotion manager. The appointee has 18 years' experience in sales promotion with Hygrade, Sylvania, Dictograph, Lennen & Mitchell, and others.

# WORLD'S GREATEST all around ELECTRIC TOOL

DRILLS . GRINDS . SANDS . SAWS  
POLISHES . SHARPENS . CARVES

The new WHIZ ELECTRIC TOOL is the handiest power tool ever made. A rugged tool for power and precision work. Drills through 3/4 inch iron plate in 42 seconds or engraves intricate designs. Handles any material: Metals—Woods—Alloys—Plastics—Glass—Steel—etc. Saves time. Eliminates labor. Plug into any socket AC or DC, 110 volts. Chuck 1/4 inch capacity. Ball bearing thrust. Powerful, triple-gear motor. STANDARD MODEL with Normal Speed (uses 200 accessories, instantly interchangeable). Price only \$7.95.

The only DRILL-TOOL with a full year's guarantee

**FREE** Accessory outfit (Value \$2) includes set of drills, mounted 1 1/2 inch grinder, sanding discs, cutting wheels, mounted brush, polishing wheel, carving burr, etc. **FREE** with each Tool ordered NOW. We pay postage.

10-DAY TRIAL — MONEY BACK GUARANTEE

PARAMOUNT PRODUCTS CO. Dept. 2RT. 545 Fifth Ave., New York

ONLY \$7.95 POSTPAID GUARANTEED FOR ONE YEAR



Big enough to last...



Dry section in aluminum can. Inverted screw mounting. Two color-coded leads for each section. Slightly over actual size, 450 v. 4 mfd.

Of course those midget metal-can electrolytics are O.K. So are cardboard-case electrolytics. But honestly, if you want an electrolytic that will last a mighty LONG LONG time, by all means spend a bit more and use an AEROVOX GL. It's BIG ENOUGH to LAST and LAST and LAST.

### AEROVOX TYPE GL ELECTROLYTICS

Single Section:  
800 v. Surge Pk.—600 v. D.C.W. 4 and 8 mfd., \$1.11 and \$1.56, your net.  
600 v. Surge Pk.—475 v. D.C.W. 4, 8, 12 and 16 mfd., \$0.75 to \$1.38, your net.  
525 v. Surge Pk.—450 v. D.C.W. 4 to 80 mfd., \$0.51 to \$2.55, your net.

Double Section:  
600 v. Surge Pk.—475 v. D.C.W. 8-8 mfd., \$1.44, your net.  
525 v. Surge Pk.—450 v. D.C.W. 4-4 to 20-20 mfd., \$0.78 to \$1.65, your net.

Triple Section:  
525 v. Surge Pk.—450 v. D.C.W. 4-4-4 to 10-10-10 mfd., \$1.14 to \$1.59, your net.  
300 v. Surge Pk.—250 v. D.C.W. 8-8-3 to 8-16-16 mfd., \$1.26 to \$1.56, your net.

Type GL 45025:  
10-10 x 450 + 20 x 25. \$1.59, your net

### Ask Your Jobber . . .

- Ask to see these popular GL electrolytics. Be sure to use them in building or servicing assemblies that must stand up under hard and steady going. Ask for catalog . . . or write direct.

**AEROVOX**  
CORPORATION  
NEW BEDFORD, MASS.  
IN CANADA: AEROVOX CANADA, Limited, Hamilton, Ont.

1941-1942  
**RADIO YEAR BOOK**  
 and **TRADE DIRECTORY**  
**COMES OUT!**

—Year round selling of  
 all radio products.

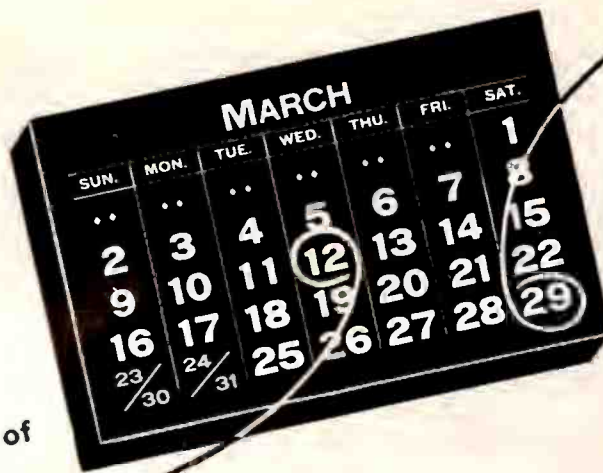

**RADIO INDUSTRY**  
 begins  
**BIGGEST SELLING DRIVE**  
**OF ALL TIME**

—Re-setting 11,000,000 push  
 button radios for the new  
 frequencies.

# 2 GREAT EVENTS IN RADIO MERCHANDISING!

## REACHING THE BUYING POWER OF THE RADIO and ELECTRONIC INDUSTRY

The Radio Year Book & Trade Directory, published annually in March as a section of RADIO TODAY, is the only trade directory that is used continuously and extensively all year long in every branch of the radio industry and trade.

All radio products are classified and listed according to trade name, name of manufacturer and address. In addition, the Year Book contains reference material of great value and usefulness.

A product advertised in the Year Book, opposite its editorial listing, has maximum prominence at all times—especially when purchasers are looking up unfamiliar sources of supply.

### USERS OF THE DIRECTORY

Handpicked lists of dealers and service dealers, sound specialists, auto radio installers, etc.

Executive, engineering, purchasing and sales heads of ALL manufacturers in the radio and electronic field.

ALL jobbers of parts, accessories, servicing equipment, sets, sound systems, etc.

Operating engineers or technicians of all U. S. broadcast stations and recording studios.

Radio engineers or technicians in aircraft and automotive factories.

Heads of U. S. government communication and recording services—including Weather Bureau, Forestry, Coast Guard, F.B.I., Army, Navy, Air Services, etc.

## REACHING MILLIONS OF HOMES, WIDE OPEN FOR RADIO SALES AND SERVICE

Radio's sweeping change of frequencies to improve reception throughout the broadcast band, will shift the dial positions on 50,000,000 radios and necessitate the re-setting of push buttons on 11,000,000 sets.

This re-allocation makes it possible for radio men everywhere in the United States to enter the homes for service and selling—an opportunity unparalleled in merchandising anywhere.

Besides setting buttons, dealers and servicemen will sell extra radios, phonographs, records, new tubes, parts, equipment, antennas, etc.—everything that can be used in home reception.

### TRADE PROMOTION ESSENTIAL

Manufacturers should lose no time in planning their participation in this great campaign. The cooperation of every possible outlet should be enlisted and the trade should be given good reasons why a particular product should be pushed.

All justifiable emphasis should be placed on the quick-selling features of a product. However, it is certain that all dealers will build up a great file of prospects for future closing; hence slower moving merchandise is also in a position to benefit.

With a tremendous job to do in a comparatively short period, dealers and servicemen will welcome sound suggestions.

In marshalling their forces for the big drive, manufacturers will find the advertising pages of RADIO TODAY extremely helpful, quick-acting and highly economical.

*Get a good  
 start in both  
 campaigns...  
 in ONE issue,  
 MARCH, 1941.*

•

*Closing date,  
 MARCH 7th.*

CALDWELL-CLEMENTS, INC.



Member . . . . . ABC

480 LEXINGTON AVE., NEW YORK

# INDEX TO ADVERTISERS

	Page
AEROVOX CORP. ....	53
AMPERITE CO. ....	46
ASTATIC MICROPHONE LAB., INC. ....	37
BITTER CONSTRUCTION CO., A ....	50
BURGESS BATTERY CO. ....	51
CINAUDAGRAPH CORP. ....	55
CONTINENTAL RADIO & TELEV. CORP., 2, 3	3
CROSLY CORP. ....	6, 7
FARNSWORTH TELEV. & RADIO CORP. ....	4
GALVIN MFG. CORP. ....	Cover IV
GENERAL ELECTRIC CO. ....	39
GENERAL INDUSTRIES CO. ....	48
HOWARD RADIO CO. ....	51
INTERNATIONAL RESISTANCE CO. ....	43
KELVINATOR DIV., Nash-Kelvinator. ....	23
KEN-RAD TUBE & LAMP CORP. ....	52
MALLORY & CO., INC., P. R. ....	Cover II
NOBLITT-SPARKS INDUSTRIES, INC. ....	1
PARAMOUNT PRODUCTS CO. ....	53
PERMO PRODUCTS CORP. ....	45
PHILCO RADIO & TELEV. CORP. ....	28, 29
POSTAL TELEGRAPH ....	49
PRESTO RECORDING CORP. ....	49
RADIO CORP. OF AMERICA ....	33
RADIO SERVICEMEN OF AMERICA ....	56
RAYTHEON PRODUCTION CORP. ....	5
RCA MFG. CO., INC. ....	8, 21
RIOER, JOHN F. ....	45
SIMPSON ELEC. CO. ....	Cover III
SONORA RADIO & TELEV. CORP. ....	10
SPRAGUE PRODUCTS CO. ....	47
SUNOT ENGINEERING CO. ....	48
SUPREME PUBLICATIONS ....	55
TRIPLETT ELEC. INSTRUMENT CO. ....	52
TURNER CO. ....	25
UTAH RADIO PRODUCTS CO. ....	35
ZENITH RADIO CORP. ....	9

While every precaution is taken to insure accuracy, we cannot guarantee against the possibility of an occasional change or omission in the preparation of this index.

## NEW BOOKLETS

New catalog of Start of the Year Line of Sonora Radio & Telev. Corp., 2626 W. Washington St., Chicago, Ill., has impressive four-color covers. All models are attractively displayed.

Bulletin 13-25 issued Jan. 1941 covers the complete line of rotary converters and dynamotors. Specifications, ratings, and prices are included in Janette Mfg. Co. 556 W. Monroe St., Chicago, Ill. booklet.

Cinaudagraph Speakers, Inc., 2 Selleck St., Stamford, Conn., have just issued new catalog covering drivers, projectors, and new semi-spherical baffled dual speaker.

The Turner Co., Cedar Rapids, Iowa, have a new Vibrator Manual with technical details of new push-pull type. Catalog 1-41 available on request.

New 48-page catalog of parts, tubes, accessories, test equipment, batteries with reference listings available from Philco Radio & Telev. distributors.

G. E. on the Farm is title of new appliance catalog listing radio and other products for rural trade. General Electric Co., Bridgeport, Conn.

Bulletins P-1 and BS-35 have been released by Atlas Sound Corp., 1447-51 39th St., Brooklyn, N. Y. P-1 describes new line of "Hold-Tite" Shielded Connectors for single conductor cable. BS-35 gives information on the new Atlas Microphone "Boom" Stand, and the DeLuxe Studio Floor Stand.

Manual containing description, diagrams and illustrations of Aerovox industrial capacitors available upon request from the Aerovox Corp., New Bedford, Mass.

Colored folder describing 3 new amplifier kits suitable for cathode modulation of RF stages or PA work. Three units include amplifiers suitable for modulating a 50, 150, and 600 watt RF stage. Kenyon Transformer Co., Inc., 840 Barry St., New York, N. Y.

Free supplementary catalog, No. 123, available from Radio City Products Co., Inc., 88 Park Pl., New York City, covers additions to their 1940-41 line since the R.C.P. Master Catalog has been issued.

New radio catalog for 1941, with sections devoted to radio; PA; parts and test equipment; etc., may be obtained from Allied Radio Corp., 833 W. Jackson Blvd., Chicago, Ill.

Essential characteristics of metal and glass radio tubes are given in latest data book of Ken-Rad Tube & Lamp Corp., Owensboro, Ky.

Ward Leonard Elec. Co., Mt. Vernon, N. Y., announces a free circular, No. 507 which covers their line of radio resistors and rheostats.

Description and illustrations of public address equipment of the Sun Radio Co., 212 Fulton St., New York City, are contained in new 24 page catalog. Copies available on request.



**"OF COURSE, IF YOU  
WANT THE BEST ..."**

On those occasions when "something just as good" won't do you can save the day with CINAUDAGRAPH.

Whether in a fine radio or 'way up on a pole . . . a CINAUDAGRAPH SPEAKER does what is expected of it in a manner that causes you to throw out your chest with pardonable pride and satisfaction.

**Send for new catalog  
STAMFORD  
CONN.**

## RADIO DIAGRAMS

**MOST - OFTEN - NEEDED**

**MOST  
OFTEN-  
NEEDED  
RADIO  
DIAGRAMS**

**4 OUT OF 5  
CIRCUITS  
YOU  
NEED**

**MOST POPULAR  
1940  
RADIO  
DIAGRAMS**

**ALL MAKES 1926-1938**

In this one low-priced manual you have all the circuits you really need. 427 diagrams of most-often serviced radios is the help you want for easier, faster, and better repairs. You will find 4 out of 5 diagrams needed in this manual. 24 large pages, large 8 1/2 x 11 in. size. Special price . . . **\$1.95**

**HOW TO SAVE TIME**

Service hints, diagrams, alignment data, test charts, and parts lists included will prove time-savers and money-makers for you. Get these handy "on-the-job" handbooks. No need to work blind-folded. The time saved in two days will more than pay for these manuals.

**1939-1940 DIAGRAMS**

This single manual will give you over 80% of all 1939-40 circuits ever needed, acquaint you with recent radio developments, and teach you how to service quickly millions of sets sold last year. Models of 43 manufacturers. 212 large pages, 8 1/2 x 11 inches. **\$1.50** Limited quantity at . . .

**FREE EXAMINATION**

SUPREME PUBLICATIONS,  
Room 548,  
3727 W. 13th St., Chicago, Illinois

SHIP the manuals checked. I must be satisfied or you will refund my money in full.

Most Often-Needed Diagrams, 1926-1938 @ \$1.95

Most Popular 1940 Radio Diagrams @ \$1.50

I am enclosing \$ . . . . ., send postpaid.

Send C.O.D. I will pay the mailman.

NAME .....

(Write address below and send this corner)

## Pennsylvania Distributing Firm Is 20 Years Old!



A distributor celebrates a 20th anniversary—the 60 employees of Anchor Distributing Co., Pittsburgh, Pa., Crosley jobber, are guests of Anchor general manager Harold W. Goldstein.

### Veteran Tube Salesman Dies in Indiana Fire

W. Clyde Mahoney, well-known radio tube salesman in the Chicago area, was a victim of the LaSalle Hotel fire in South Bend, Ind. He was the oldest Hygrade Sylvania renewal tube salesman in length of service, and was traveling one of his regular circuits when the tragedy occurred.

### Amperite Licenses RCA

News from Amperite Co., 561 Broadway, New York City, is that it has licensed the Radio Corp. of America on the Amperite-owned U. S. patent 2,196,342, which covers the use of the acoustic compensator with velocity microphones. The compensator permits adjustment of the pitch of the mike for close or distant pickup.

### Connelly Opens Elaborate New Quarters

A gala "open house" event has been held by the F. B. Connelly Co., pioneer distributors in Washington, Oregon and Alaska, to celebrate the opening of the firm's new home at 1015 Republican St., Seattle, Wash.

The new quarters include a display room half a block long, with displays of radios, appliances and housewares arranged on four levels.

Connelly, who has been in business 58 years, has branches at Portland, Ore., and at Great Falls and Billings, Mont. The firm was headed by the late F. B. Connelly. Other officers of the company's coast operations are Kenneth Connelly, Frank Porter, and R. O. Driesbach. Department heads include H. A. Thomas, O. E. Haydon, George Shephard, M. E. Kronmeyer, and Albert Witte.

### Run on Personals in Ohio

A buying spree in Cincinnati, on the RCA "personal" radios, has been reported by Shuster Electric Co., RCA distributor there. A new high in retail demand was reached as visitors and residents crowded in for the small radios, and dealers used liberal newspaper ads. Nearly three-quarters of Shuster's extra supply of the tiny sets, were sold to consumers in less than two weeks.

*We're Not Fooling, Mr. Serviceman!*

➔ **NATIONAL DUES IN THE RSA ARE**  
➔ **ACTUALLY ONLY \$1.00 A YEAR**



Yes—it seemed amazing . . . incredible . . . but Servicemen found it was true. Now hundreds of applications are pouring in from all parts of the country!

Just think—a full year membership in the National RSA for only \$1.00 (that's less than 2c a week).

You get the RSA Membership Certificate and the RSA House Organ. You have access to RSA Technical Helps Bureau, and you can participate in all the other functions and benefits RSA offers.

**RADIO SERVICEMEN OF AMERICA, Inc.**

*"Reliable Service Assured"*

**JOE MARTY, JR., Executive Secretary**  
304 S. DEARBORN STREET • CHICAGO, ILL

It's your big chance to join with thousands of your fellow Servicemen in this great national organization and have a voice in your own destiny. It's your big chance to help yourself get ahead in your industry.

Protected territories will be established as rapidly as local chapters are formed. Applicants in present chapter areas will be referred to the local chapter.

Fill out the coupon, attach a \$1.00 bill and mail it in today.

**RADIO SERVICEMEN OF AMERICA, INC.**  
304 S. Dearborn Street, Chicago, Illinois

\$1.00 enclosed for 1941 National Dues in RSA

Name.....

Address.....

City..... State.....

*Radio Today—Feb.*

**MODEL 450  
"TEST MASTER"**

Here the Model 300 is broadened to cover set testing. In addition to the tube tests of the No. 300 it has, as a set tester, 8 A.C. voltage ranges; 5 resistance ranges; 5 milliamperage ranges; 5 Decibel ranges. Your net price..... **\$3975**



**MODEL 300 TUBE TESTER**

Here is a typical Simpson value. Tests octals, single ended tubes, bantams, midjets, miniature, ballast tube, gaseous rectifiers, Christmas bulbs, etc. Filament voltage from .5 to 120 V. Has three-way switching, neon short check, "good" and "bad" scale; percentage scale; tube charts in cover. Your net price..... **\$2650**

# Who builds the best testers?

**A**FTER all, there can only be one *best* in any field. Who makes it? Who makes the best automobile—or screwdriver—or anything you need?

People are asking that question with more intensity today than they ever asked it before . . . and they *should*. Twenty years ago, when every manufacturer worked with practically the same materials and methods that everyone else in his field used, the best thing in any field was almost necessarily the highest priced thing available. But in recent years people have had their eyes opened.

Today, materials and methods and ideas are changing so rapidly that the manufacturer who held the lead *last* year may very easily *lose* it *this* year. You have seen makes of high priced automobiles pass into oblivion, not because they were not conscientiously built but because someone saw a "smart way" to make nine hundred dollar's worth of machinery do tricks that three thousand dollar's worth had failed to accomplish!

In the light of examples like that, we invite you to ask the question, "who builds the best testers?" In

seeking the answer forget manufacturers' names entirely and weigh basic worth against basic worth—idea against idea—workmanship against workmanship—record against record—straight through the list of radio testing equipment.

In such a comparison, we feel confident that you will find in Simpson Testers another one of those examples of smarter coordination of materials, methods and ideas that is re-shaping the trend of an industry.

Why? Because we came into the field with unsurpassed experience, but with a totally *fresh* viewpoint. That combination of advantages inspired the finer Simpson basic meter with bridge-type construction and soft iron pole pieces . . . the Roto-Ranger idea . . . the three-way switching idea . . . the "replaceable unit" idea . . . the countless other ideas that jolted testing equipment out of the rut into which it had fallen.

Three examples of this—but only three of the many—are illustrated here. Consider the *extra value* that these instruments represent and you have the answer to that vital question: "Who makes the best?"

**MODEL 400  
TUBE TESTER**

A useful and impressive instrument. "Unit design" guards against obsolescence. Note visual guide tied in with new, Simpson speed-roll chart. Has three-way switching. Your name engraved free on panel at net price of..... **\$3600**



**SIMPSON ELECTRIC COMPANY**

5216-18 Kinzie Street, Chicago, Illinois

# Simpson

INSTRUMENTS THAT STAY ACCURATE



# Motorola Auto Radio



**CHALLENGES  
ALL  
COMPETITION**

**WINS  
ON  
DEMONSTRATION**

# Free!

## **This Powerful "TORPEDO"**

### **Demonstration Board**

**Get Your Complete 1941  
Auto Radio Department  
Now While Sales Are  
Good! See Your Distributor  
for Information on How  
to Get This Display FREE!**



**3-DIMENSION**

# VITA-TONE

**MAKES 1941 *Motorola* EASY TO SELL  
PAYS WORTHWHILE PROFITS, TOO!**

**BIGGEST NATIONAL  
ADVERTISING PROGRAM  
50 MILLION READERS**

**SATURDAY EVENING POST  
LIFE  
COLLIER'S  
AMERICAN WEEKLY  
AMERICAN MAGAZINE  
RADIO AND MOVIE GUIDE**

**GALVIN MFG. CORPORATION · CHICAGO**